

**SOOPSORI
Puzzle
Play Manual**



1. 기초 1) 크기 비교하기

- 도형의 크기와 높낮이, 길이를 비교해 보세요. -



=

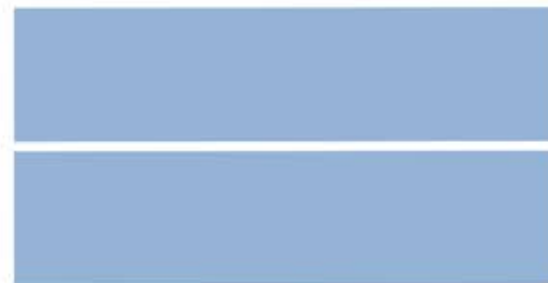
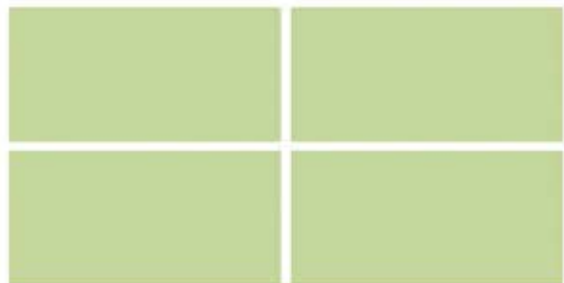



=

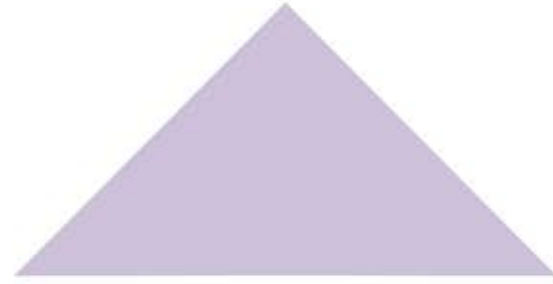

=





=



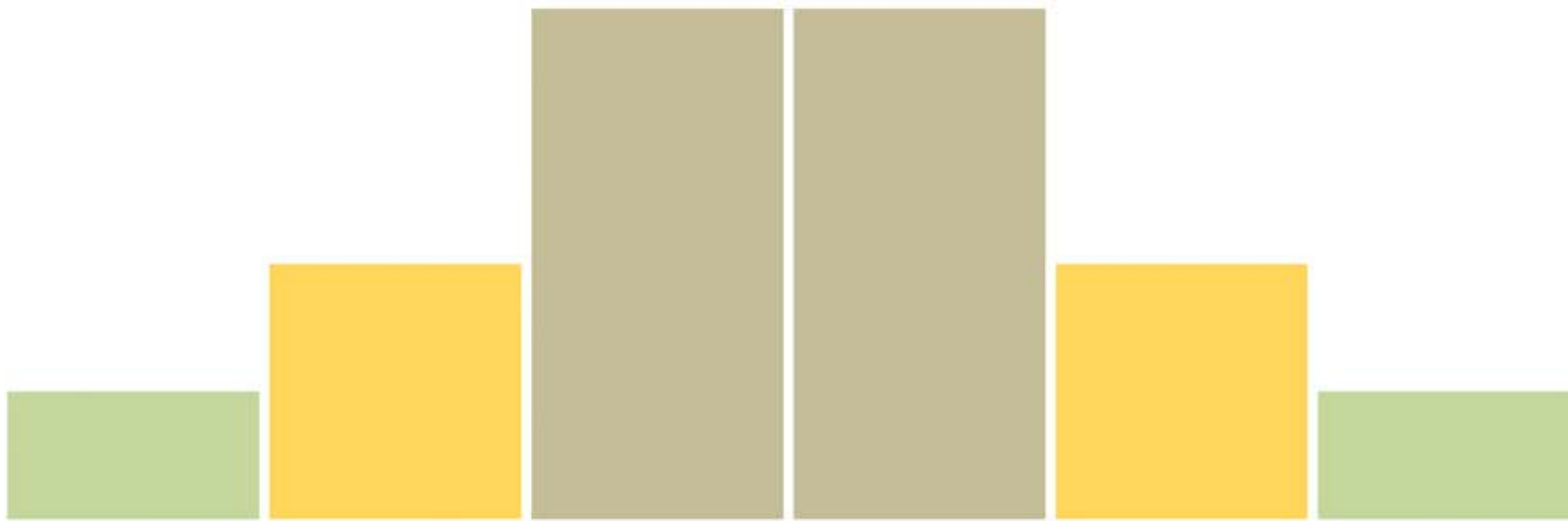

2. 모양 만들기

- 실 사이즈입니다. 그림 위에 도형을 찾아 맞춰 보세요 -

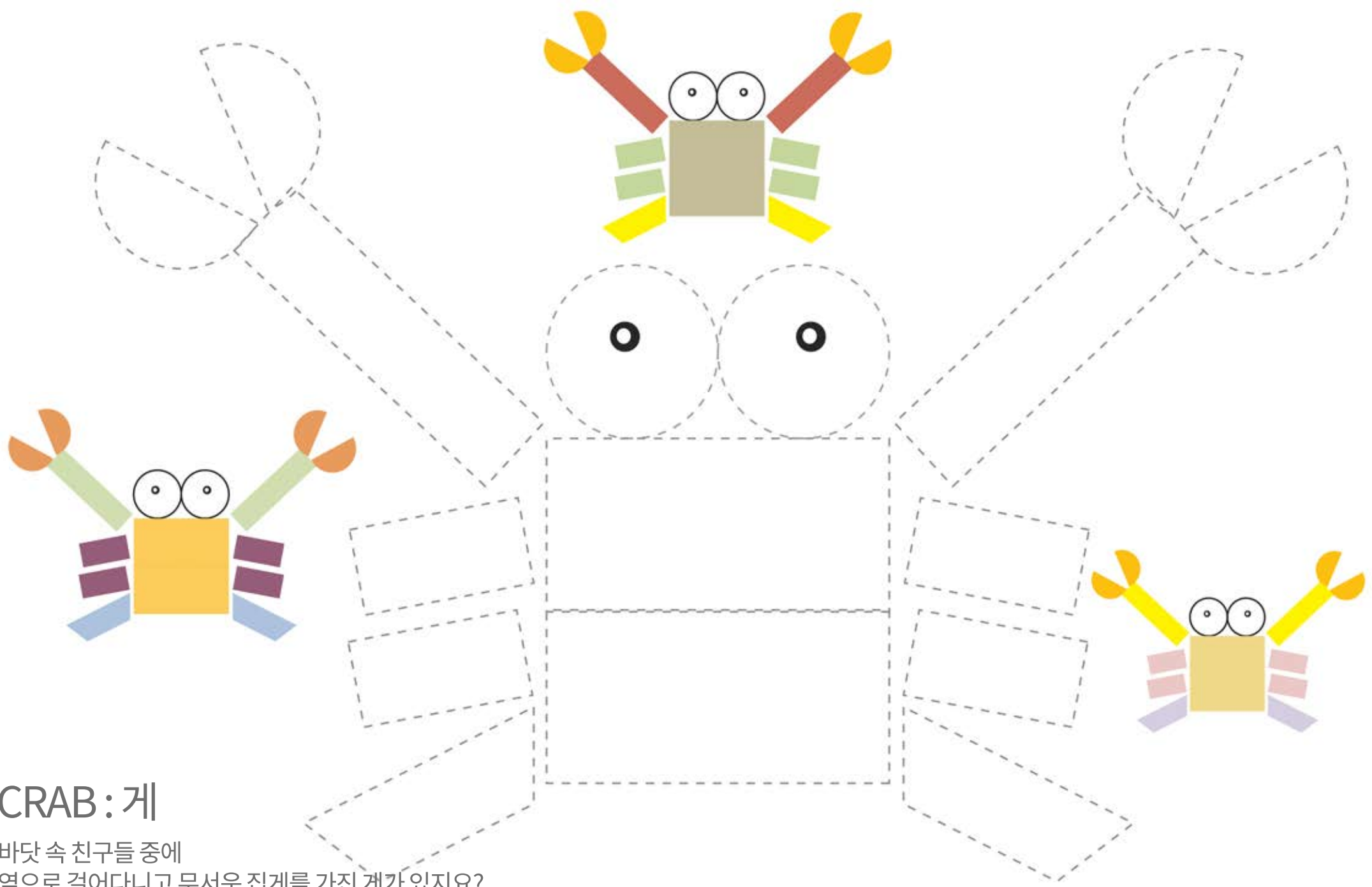

CRAB : 게

바닷속 친구들 중에
옆으로 걸어다니고 무서운 집게를 가진 게가 있지요?
게 퍼즐을 맞춰 보아요.

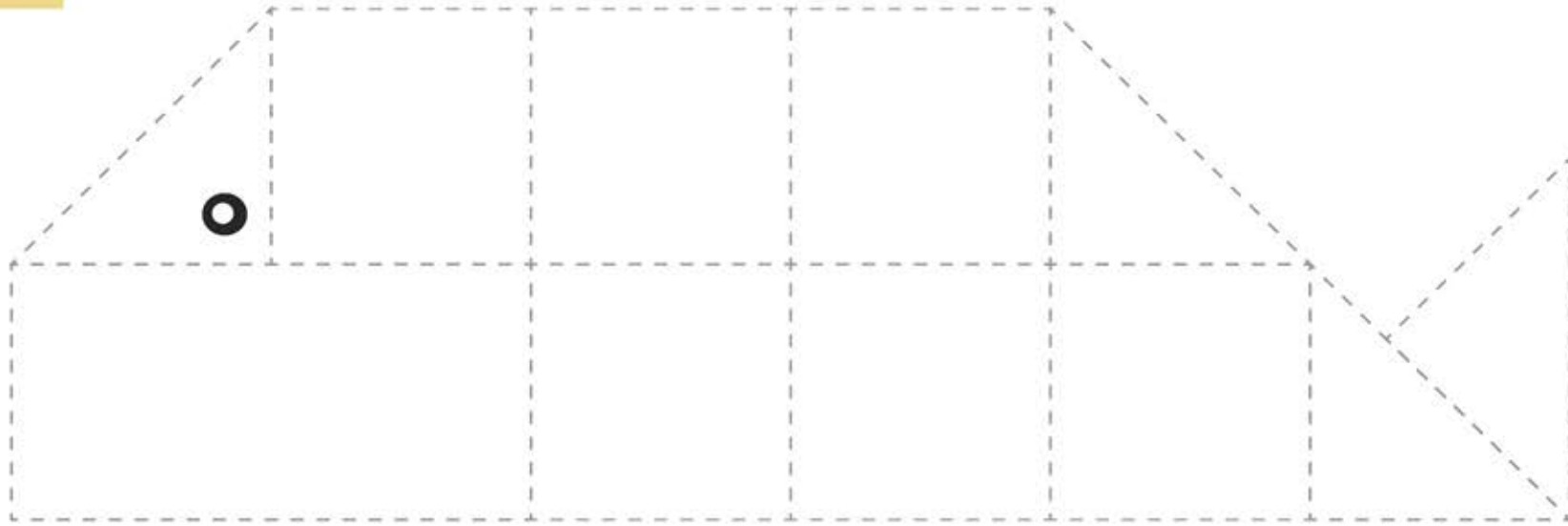
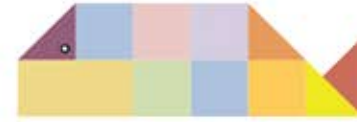

WHALE : 고래

넘실넘실 파란 바다속을 자유롭게
헤엄치는 귀여운 고래
고래가 헤엄칠 수 있도록 완성해 볼까요?

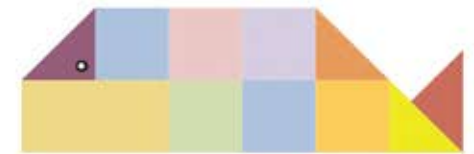

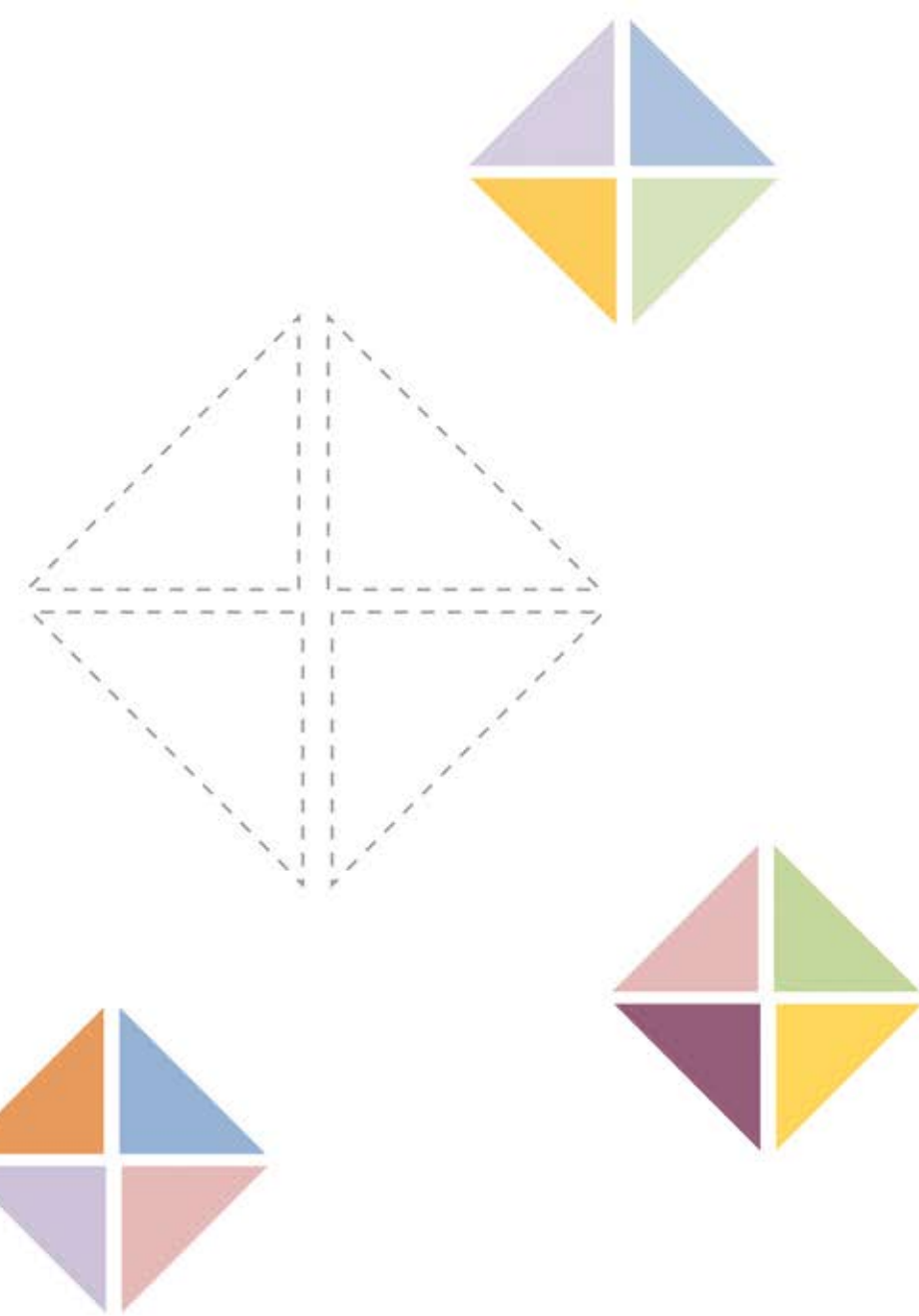
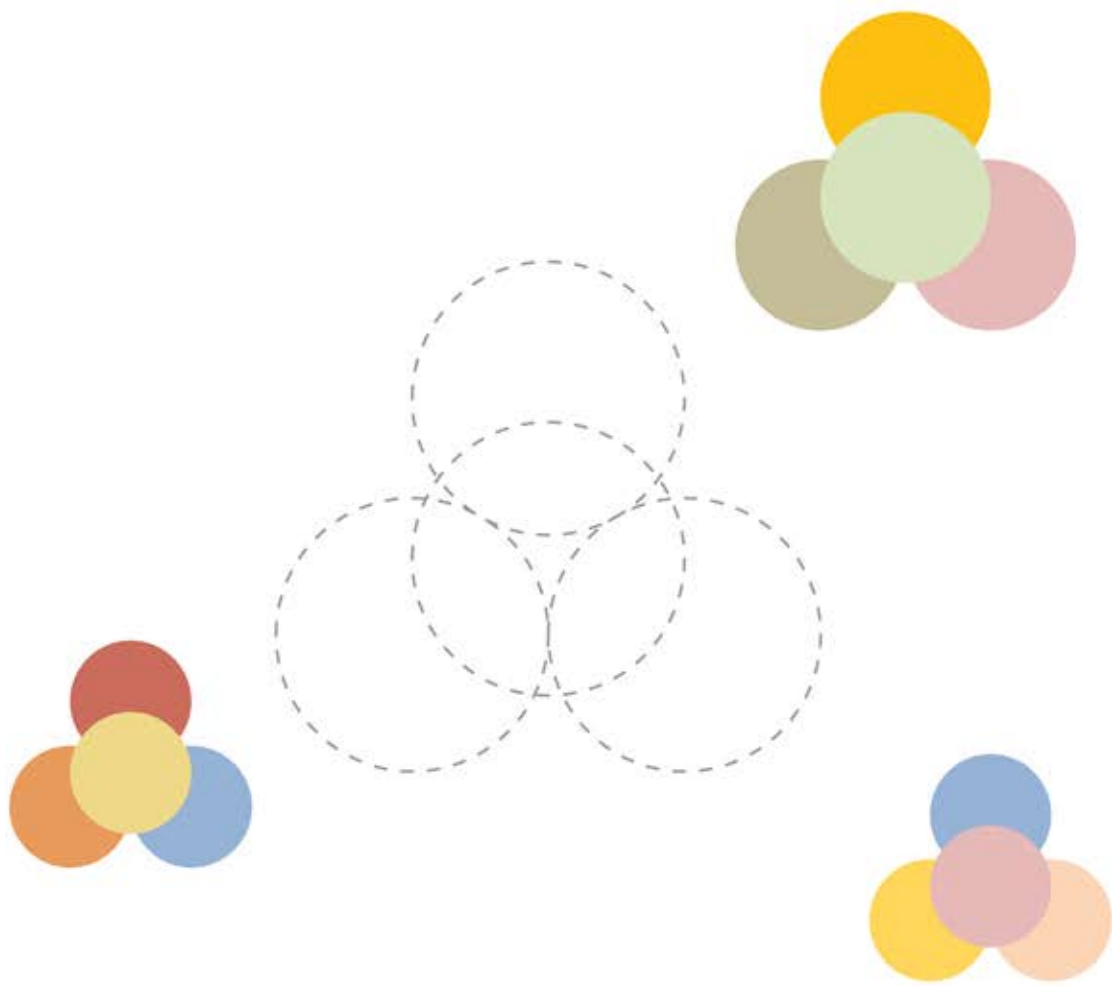

FLOWER: 꽃

산에 들에 알록달록 피어있는 꽃들
우리도 꽃을 피워낼 수 있어요.
아름다운 꽃을 만들어 볼까요?

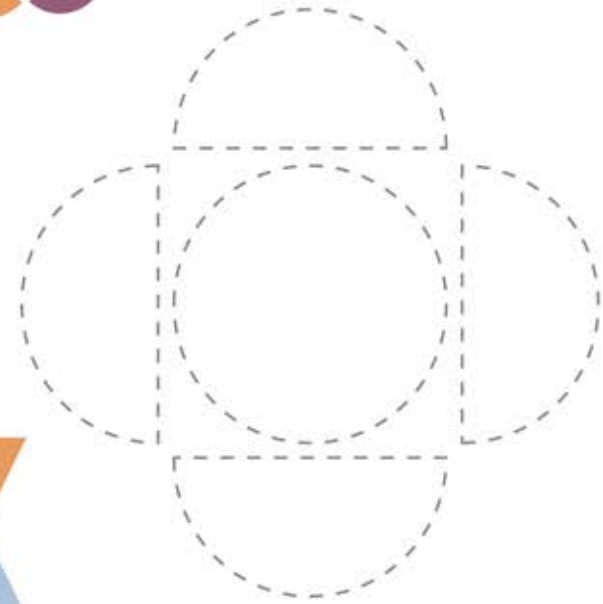
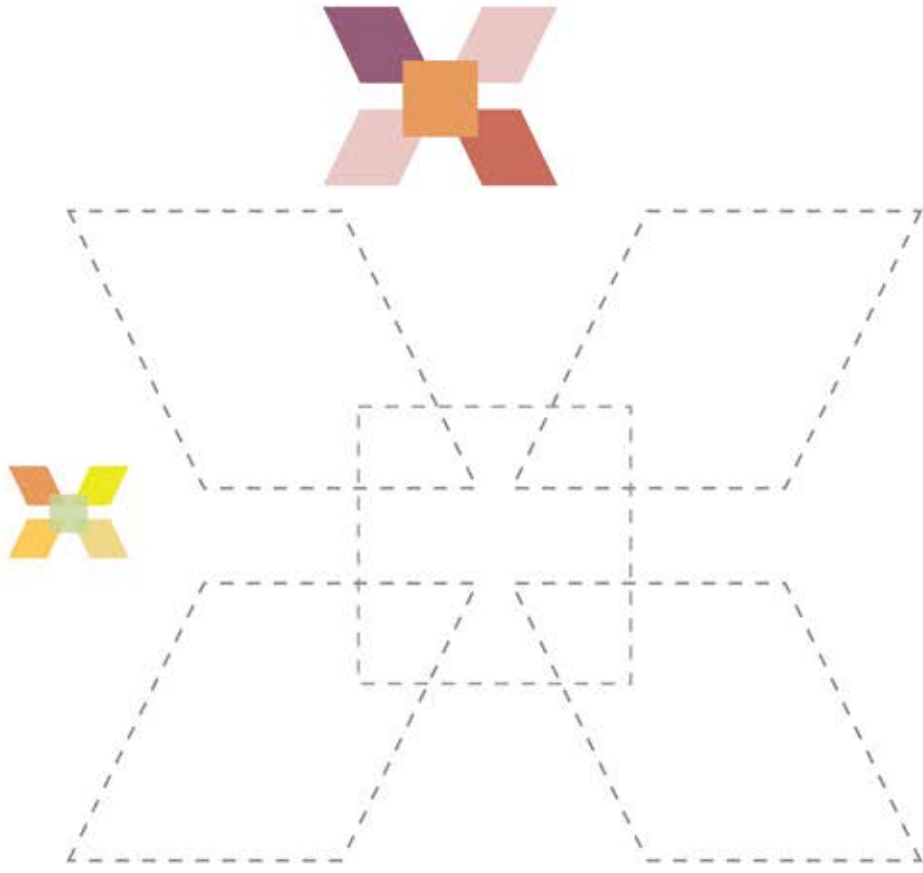

FLOWER: 꽃

산에 들에 알록달록 피어있는 꽃들
우리도 꽃을 피워낼 수 있어요.
아름다운 꽃을 만들어 볼까요?



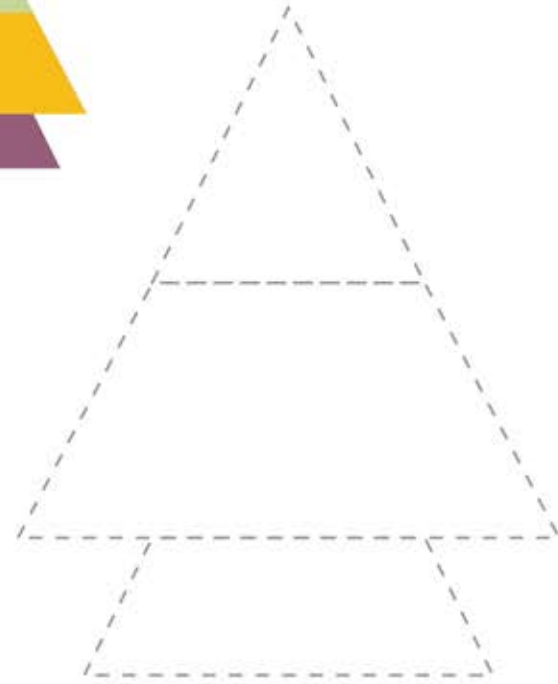
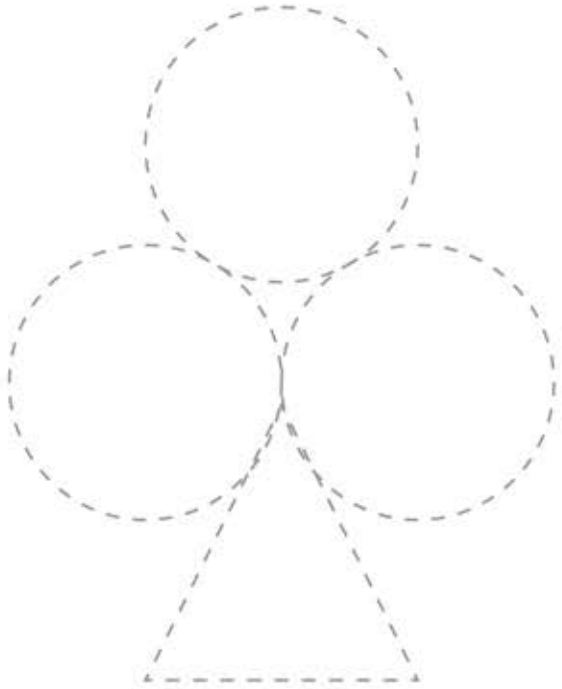

TREE : 나무

푸르른 산에는 몸과 마음을
편안하게 해주는 나무들이 많지요!
고마운 마음을 담아 나무를 만들어 볼까요?

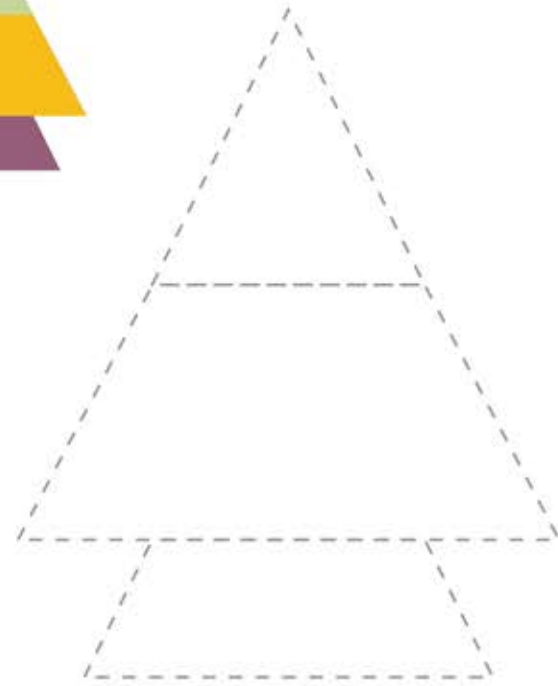
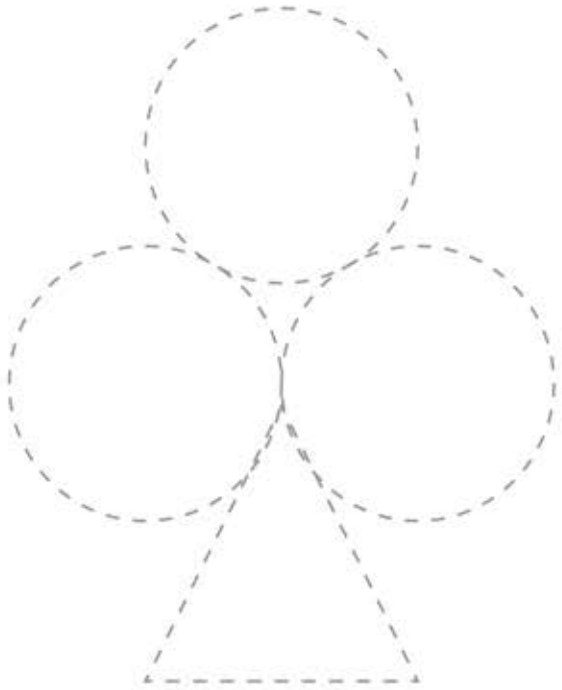

TREE : 나무

푸르른 산에는 몸과 마음을
편안하게 해주는 나무들이 많지요!
고마운 마음을 담아 나무를 만들어 볼까요?

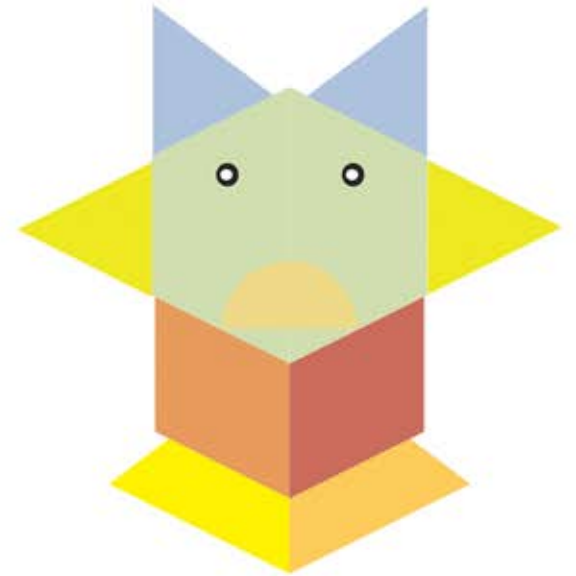
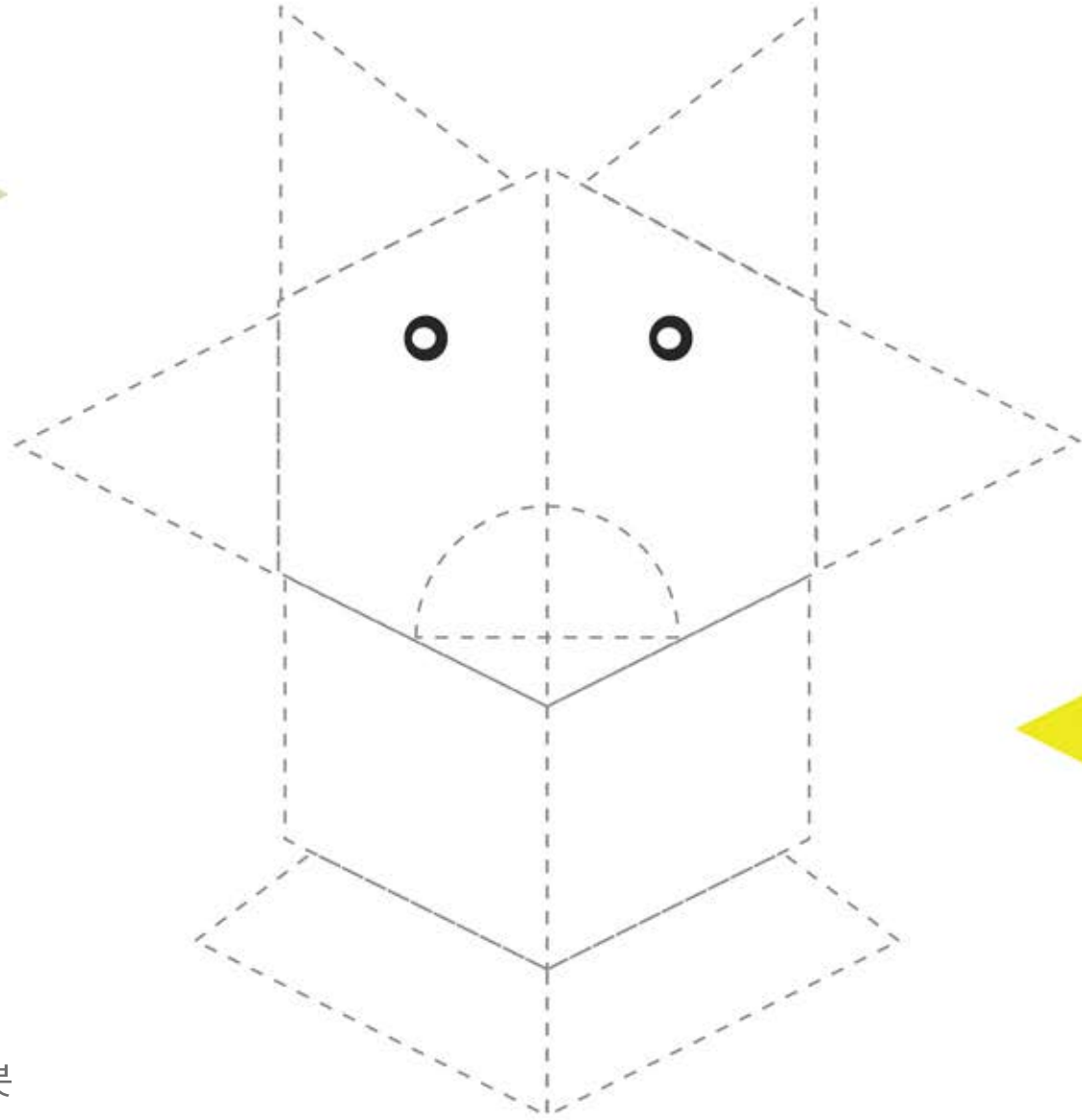
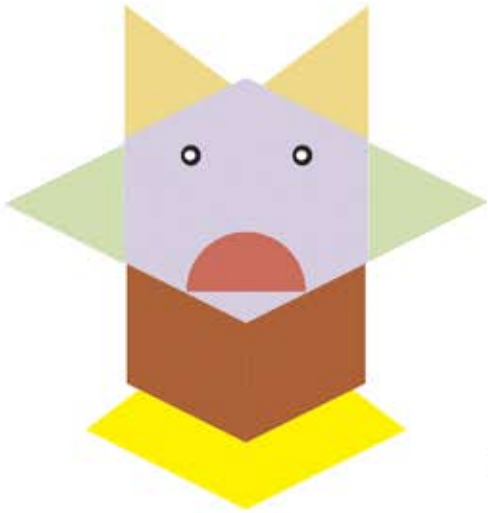

ROBOT : 로봇

우리들의 친구 용감하고 똑똑한 로봇
로봇을 함께 만들어 볼까요?

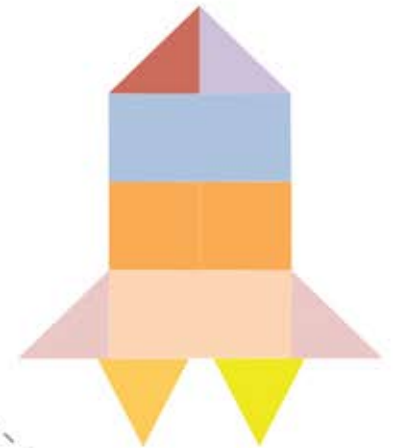
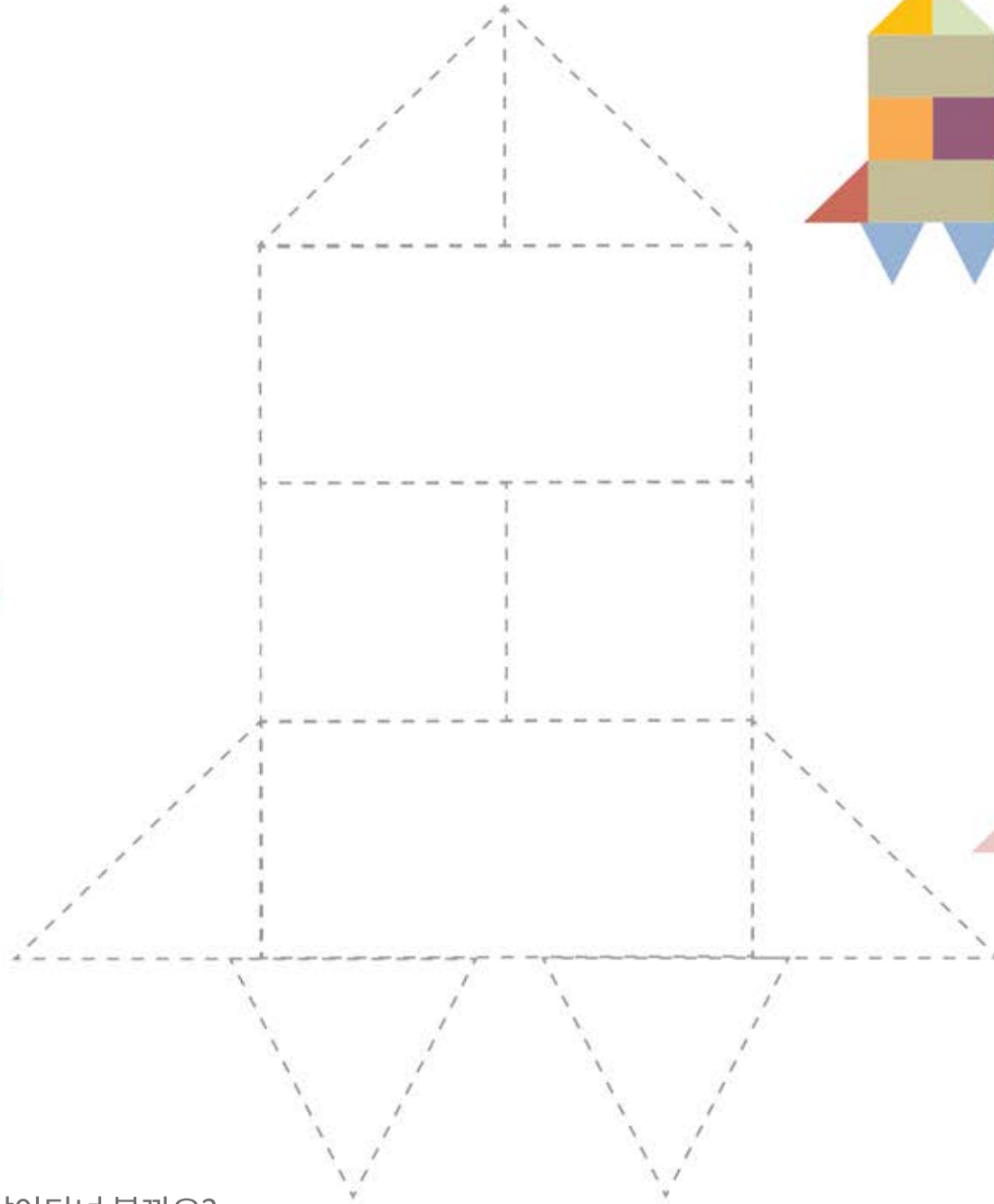
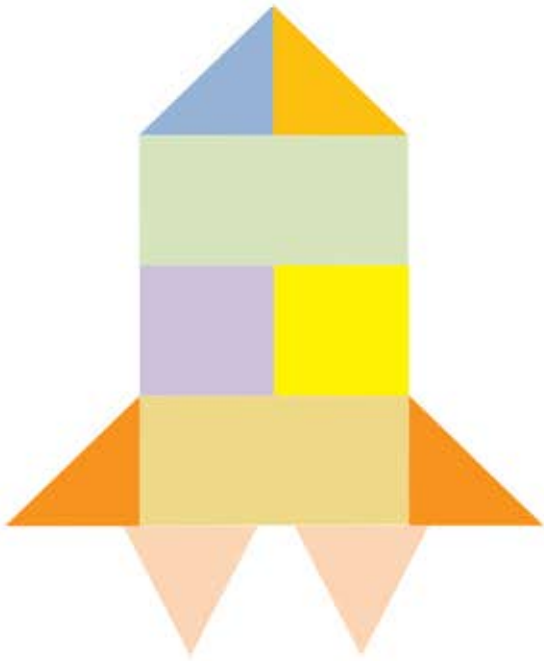

ROCKET : 로켓

하늘 위를 나는 멋진 로켓
로켓모양 퍼즐을 맞춘 뒤
꿈 속에서 로켓을 타고 영화속 주인공처럼 날아다녀 볼까요?

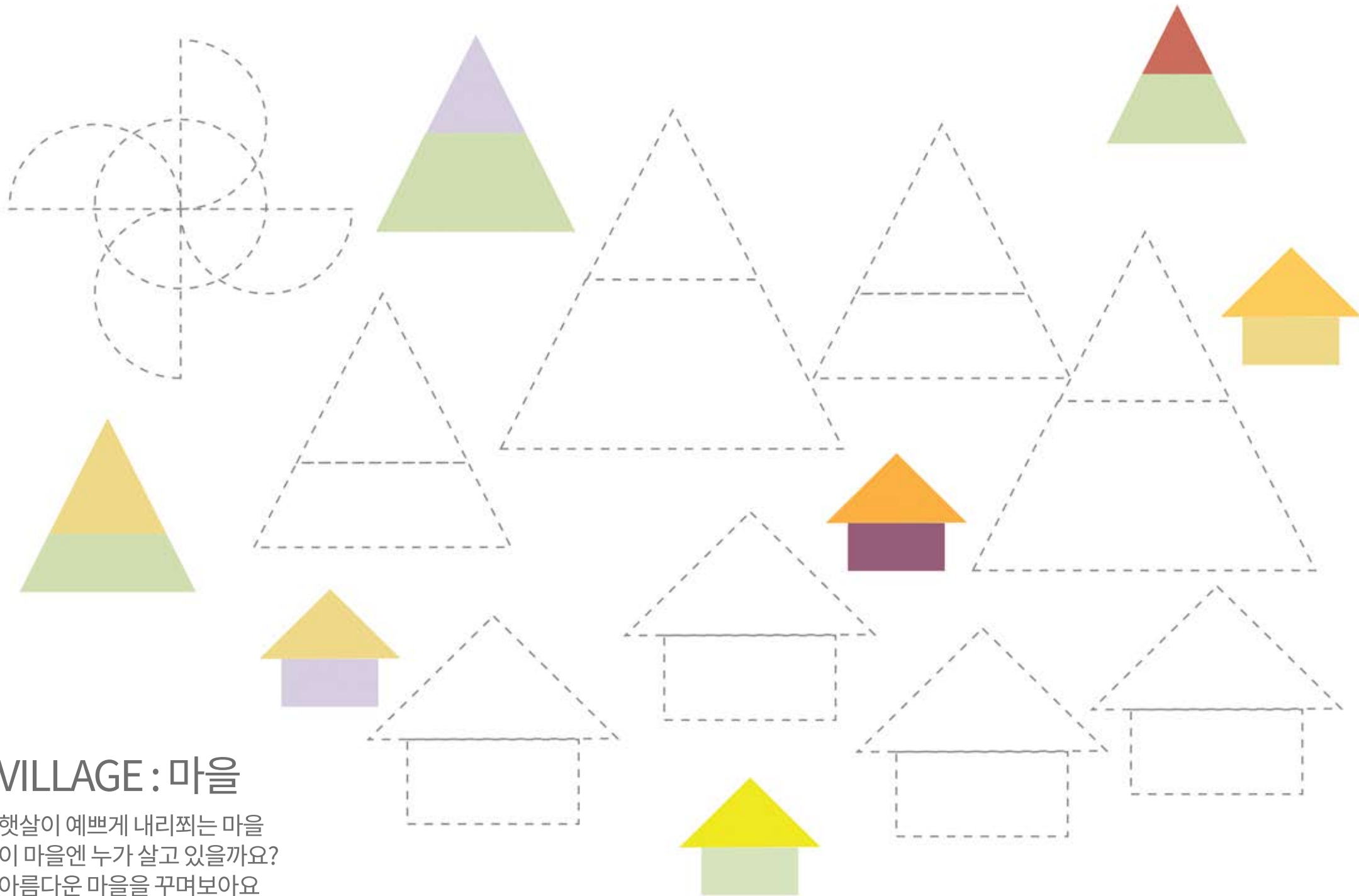

VILLAGE : 마을

햇살이 예쁘게 내리쬐는 마을
이 마을엔 누가 살고 있을까요?
아름다운 마을을 꾸며보아요

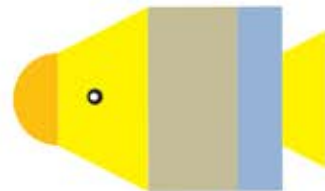
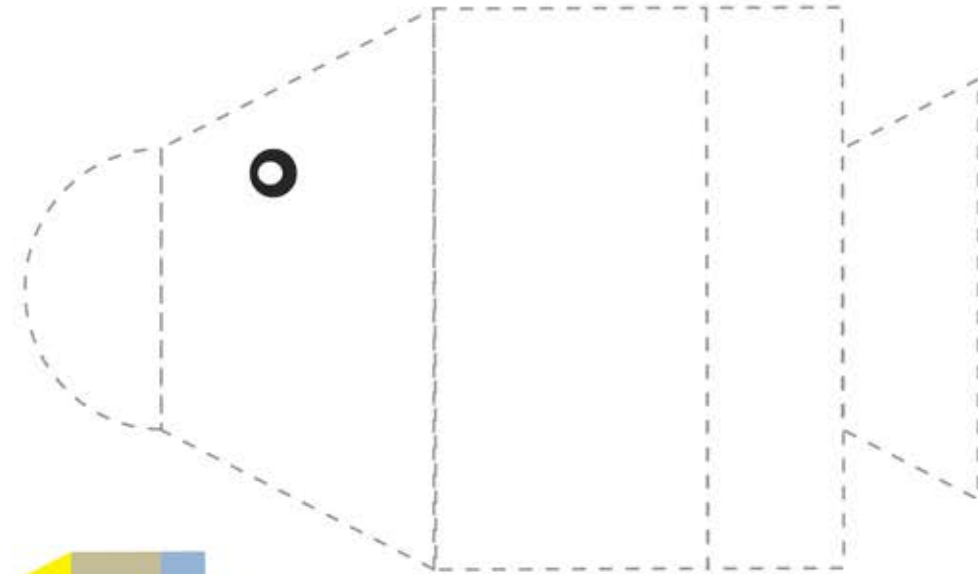
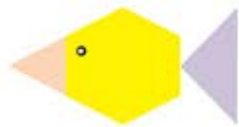
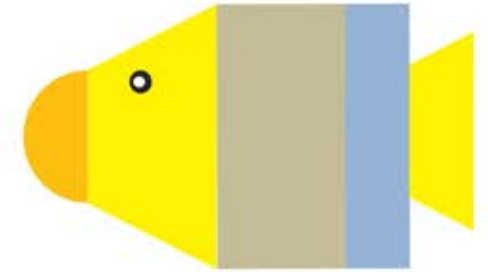
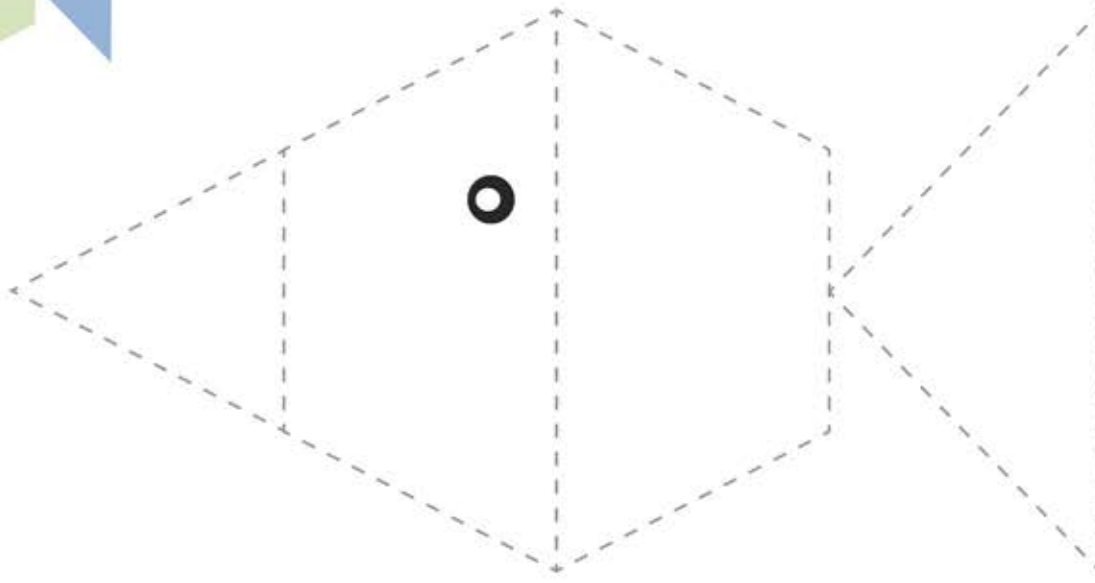

FISH : 물고기

물 속에서 자유롭게 헤엄치는
귀여운 물고기들이에요.

뼈끔뼈끔 물고기를 따라하며 퍼즐을 맞춰 보아요.

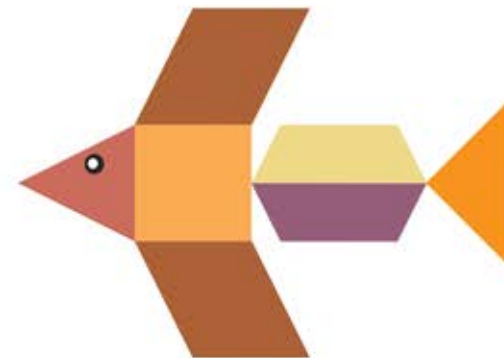
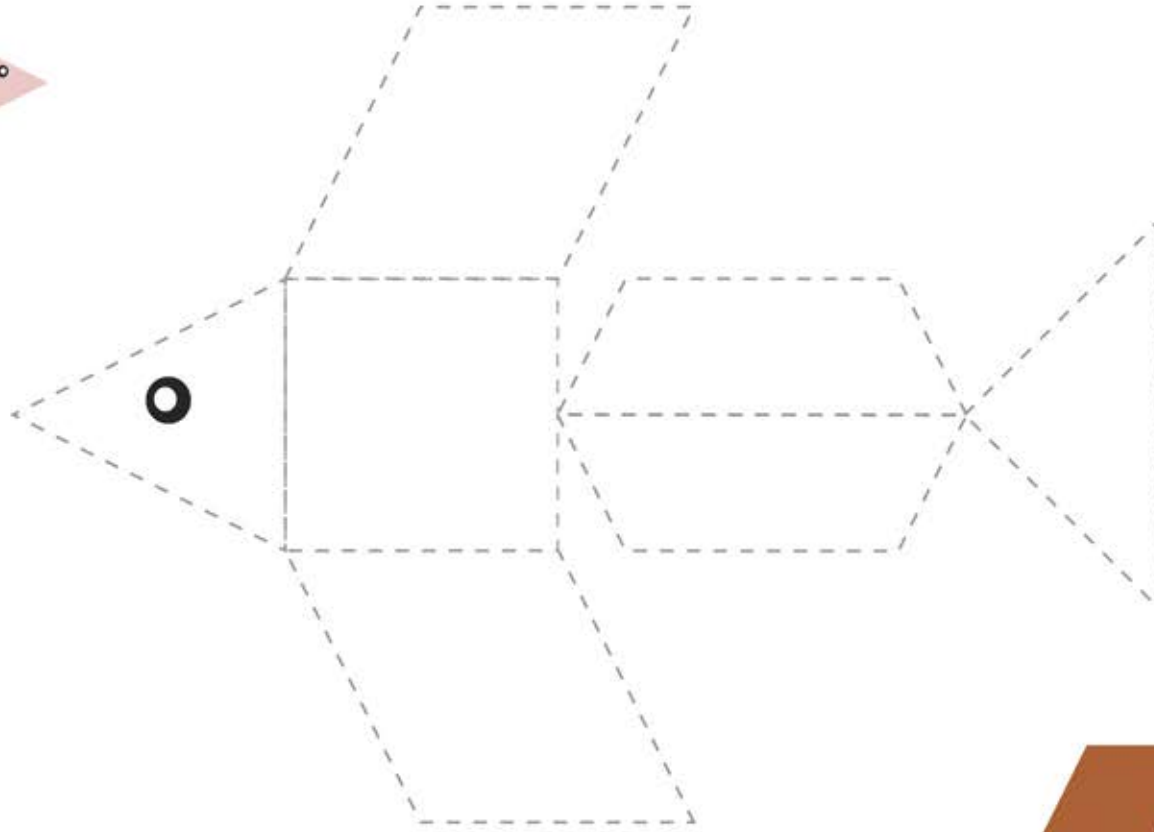

FISH : 물고기

물 속에서 자유롭게 헤엄치는
귀여운 물고기들 이에요.

뼈끔뼈끔 물고기를 따라하며 퍼즐을 맞춰 보아요.

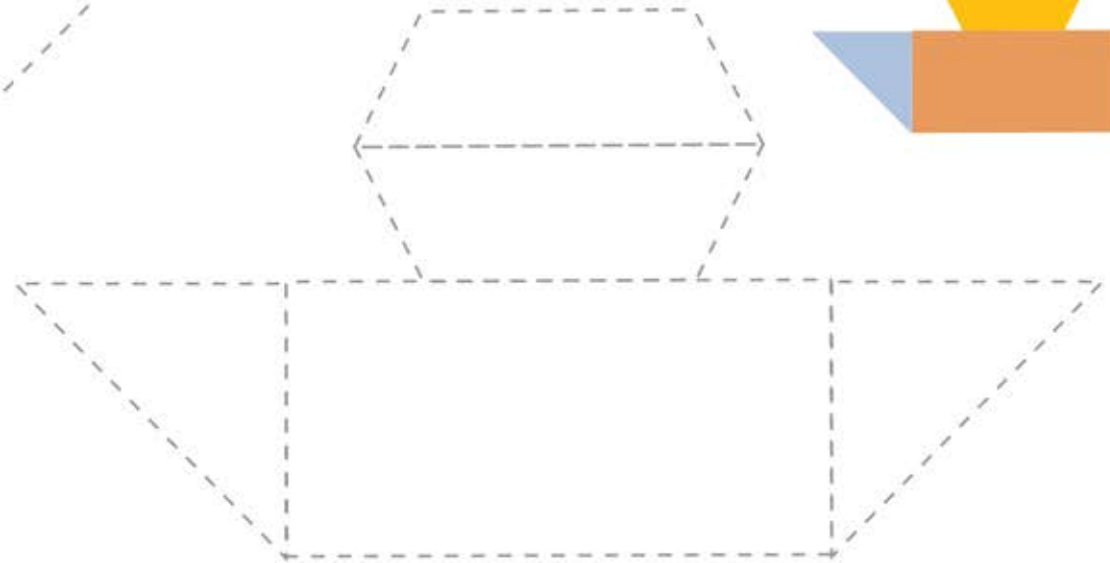
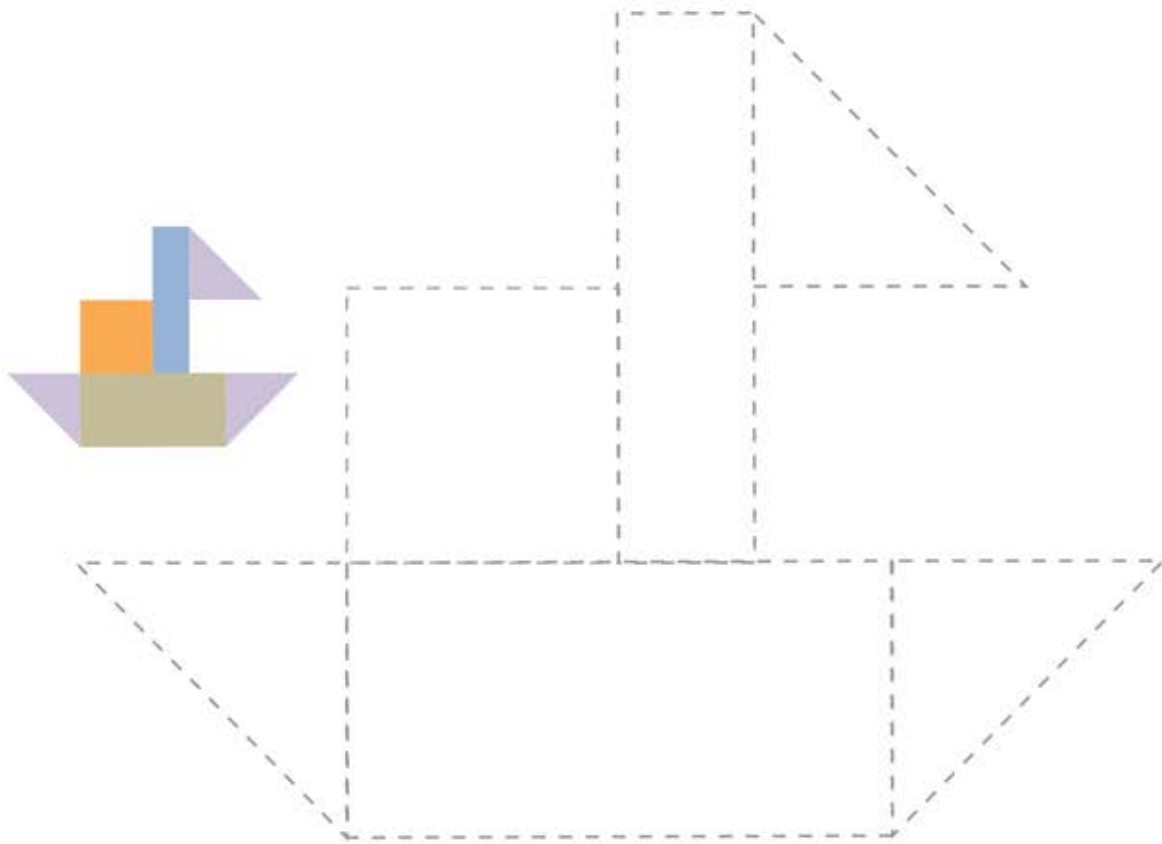

SHIP : 배

바닷가에 배가 둥둥 떠 다녀요~
어디로 가는 중 일까요?
우리도 똑딱 만들어 바다에 띄워보아요.

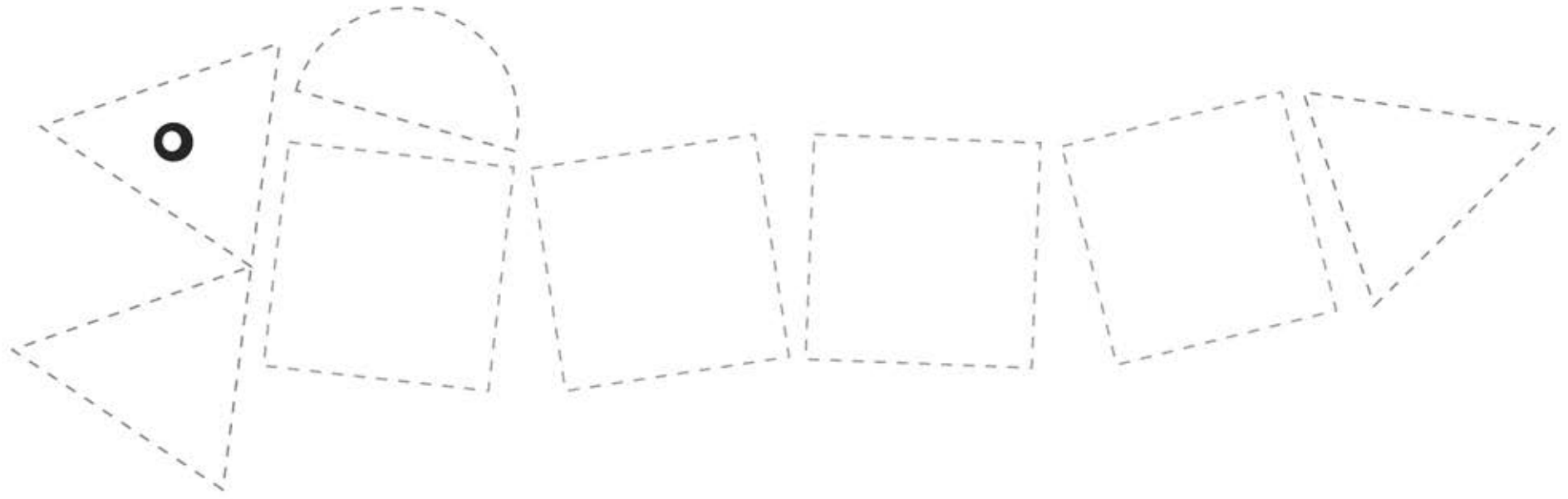

SNAKE : 뱀

긴 몸으로 꿈틀꿈틀 움직여서
무언가를 향해 입을 벌리고 있는
귀여운 뱀. 뱀을 만들어 보아요

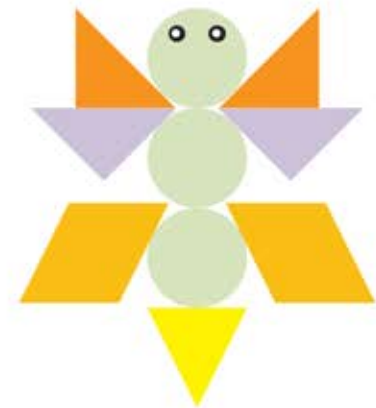
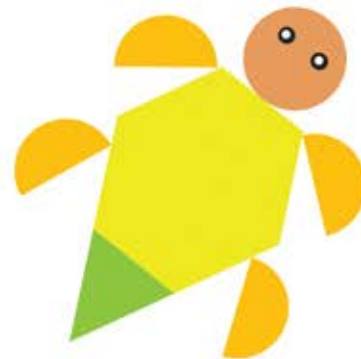
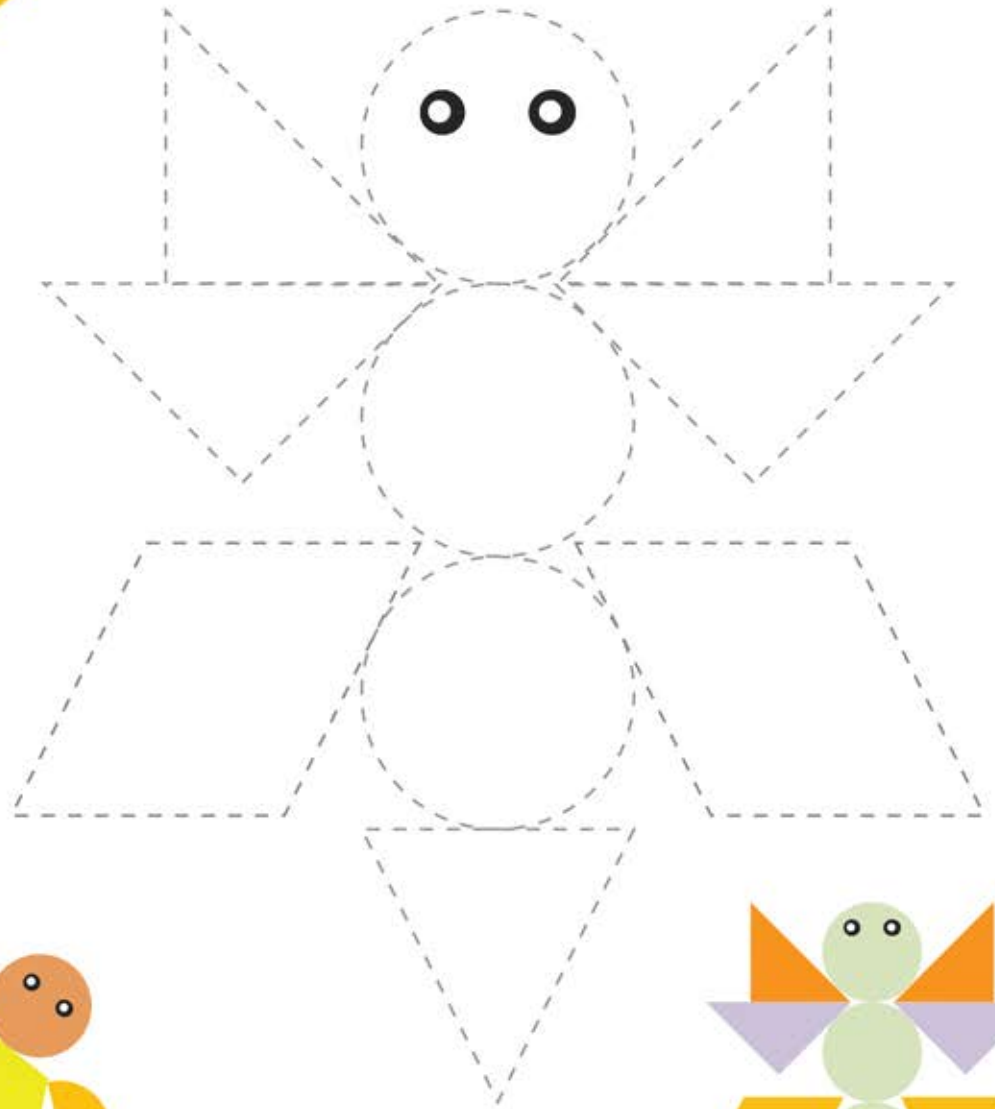
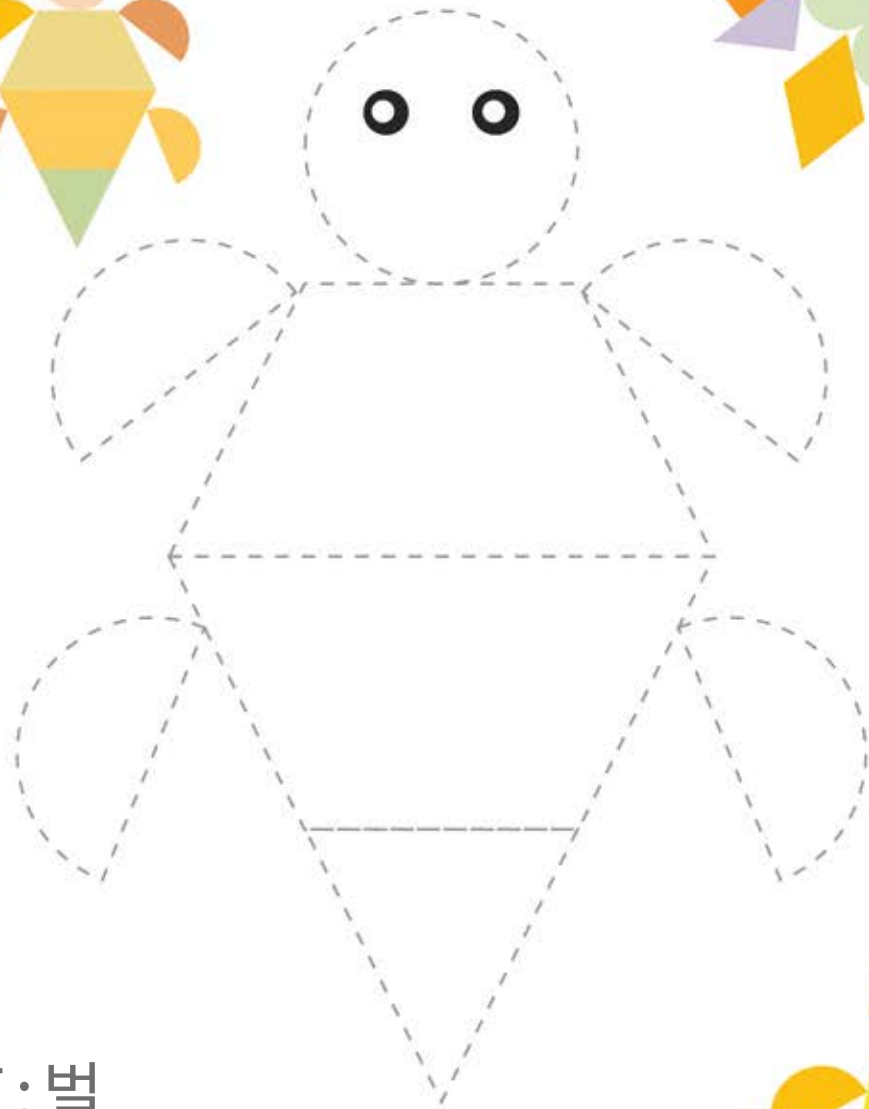
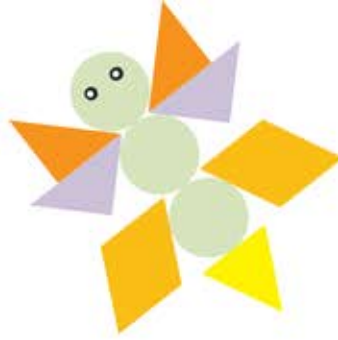

BEE : 벌

벌은 열심히 꽃의 달콤한
꿀을 모아 자신의 집에 모은답니다.
우리 함께 벌의 퍼즐을 맞춰 볼까요?

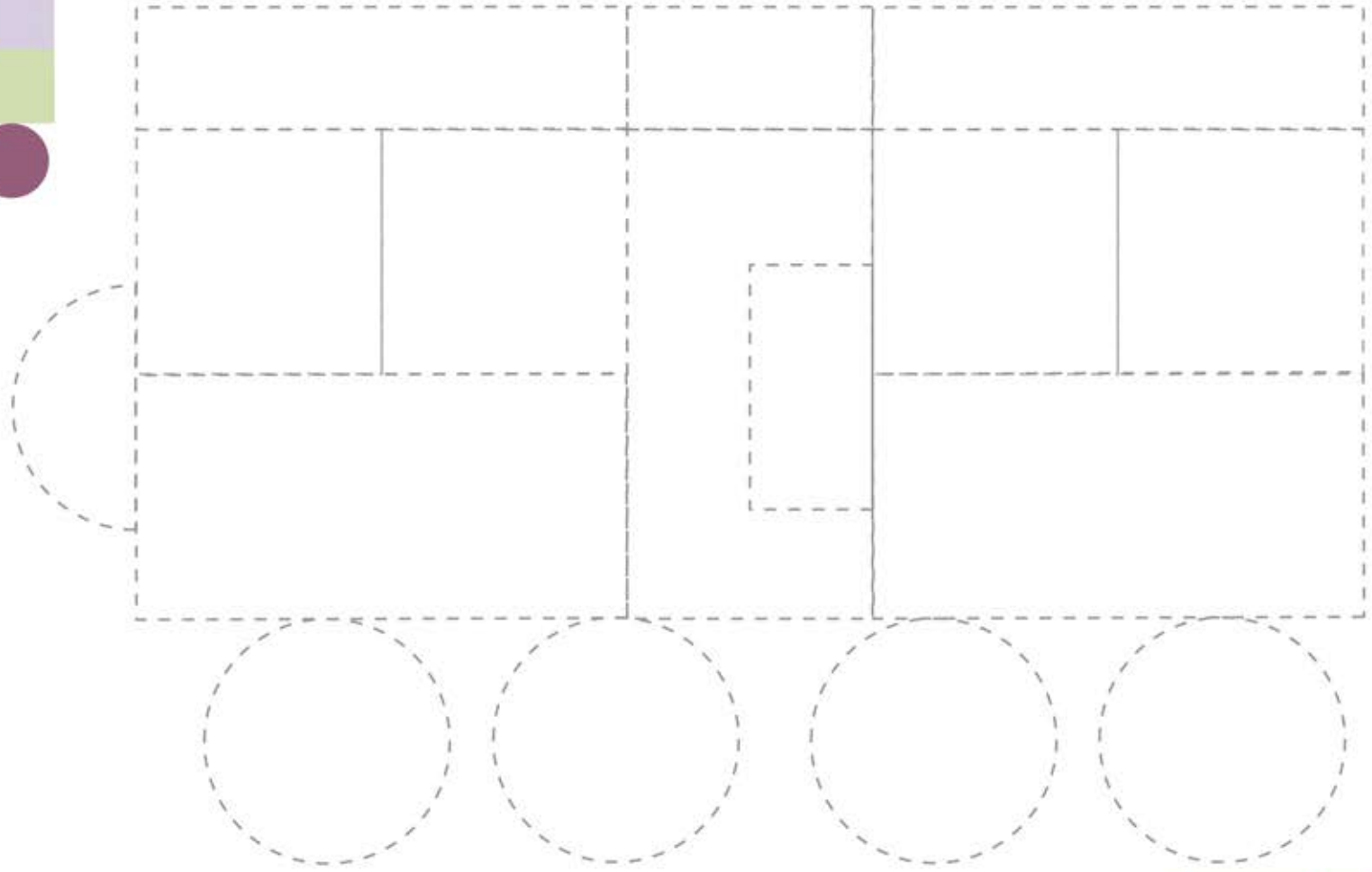
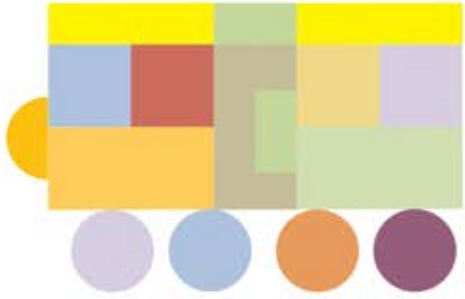

BUS : 버스

많은 사람들을 목적지까지 쉽게
이동할 수 있게 해주는 고마운 버스.
기다란 버스의 퍼즐조각을 맞춰요.



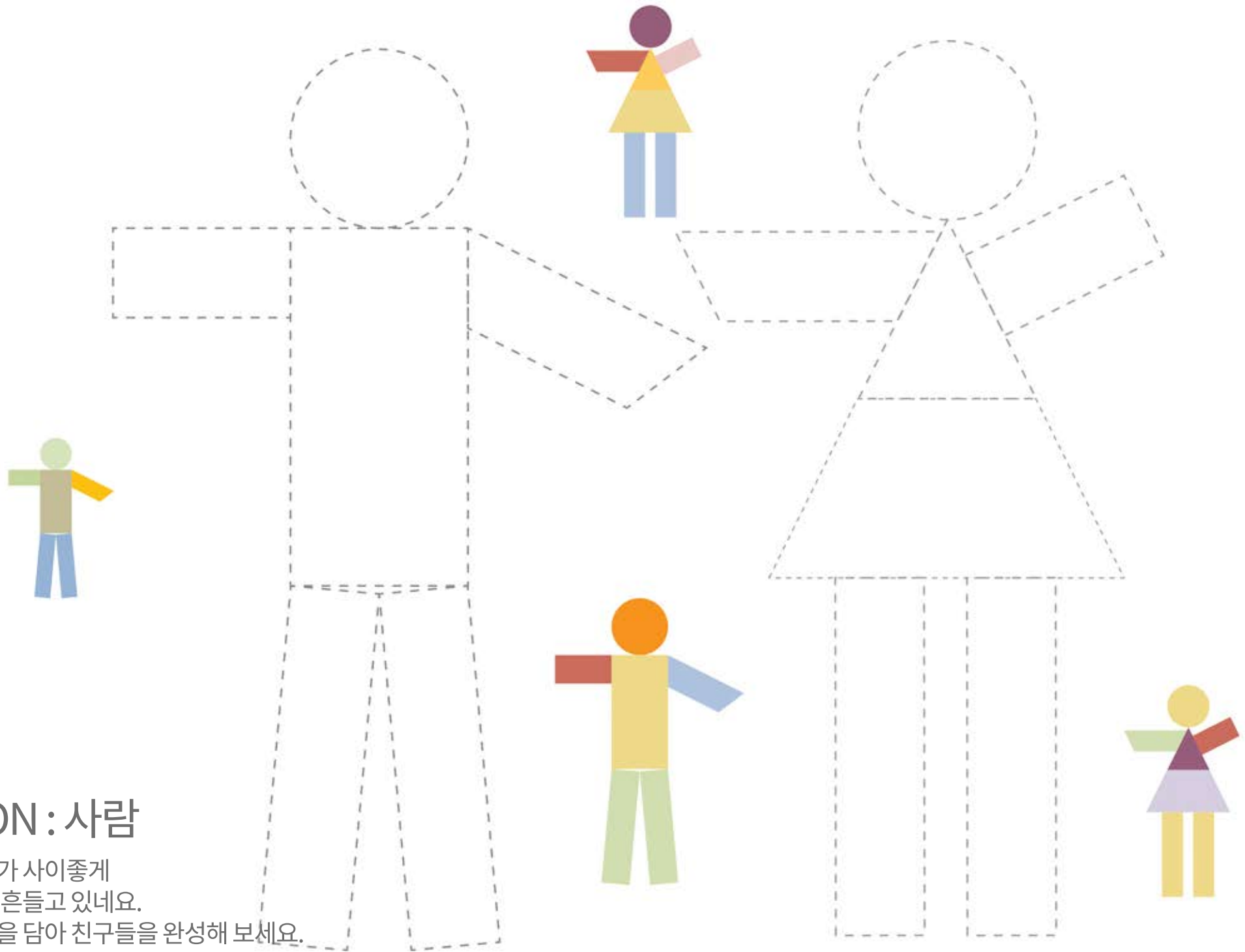

PERSON: 사람

소년과 소녀가 사이좋게
나란히 손을 흔들고 있어요.
반가운 마음을 담아 친구들을 완성해 보세요.

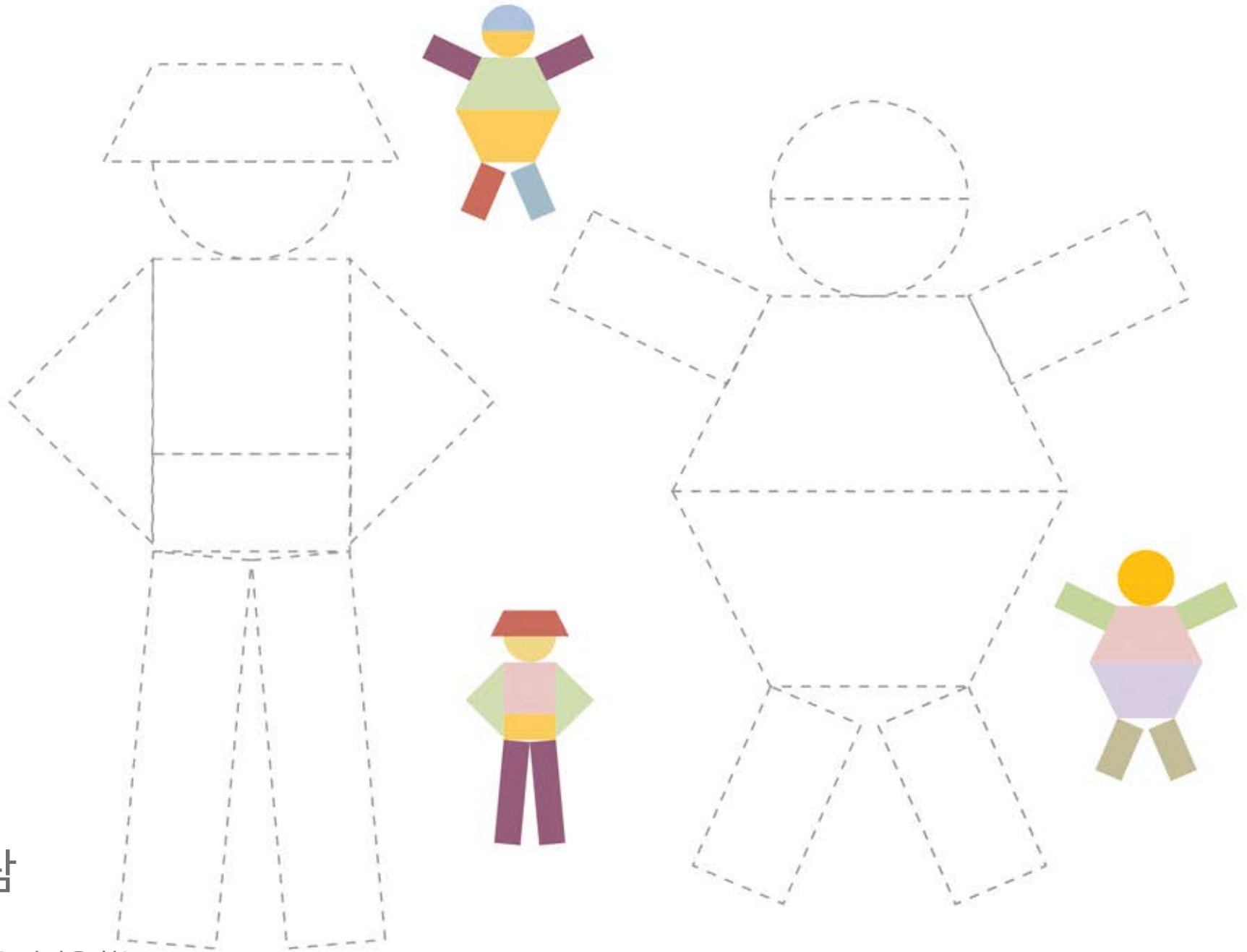
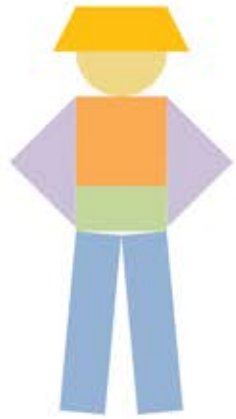

PERSON: 사람

퍼즐을 하나하나 맞추고
우리 주변에서 그림과 닮은 사람을 찾는
즐거운 시간을 가져보세요.

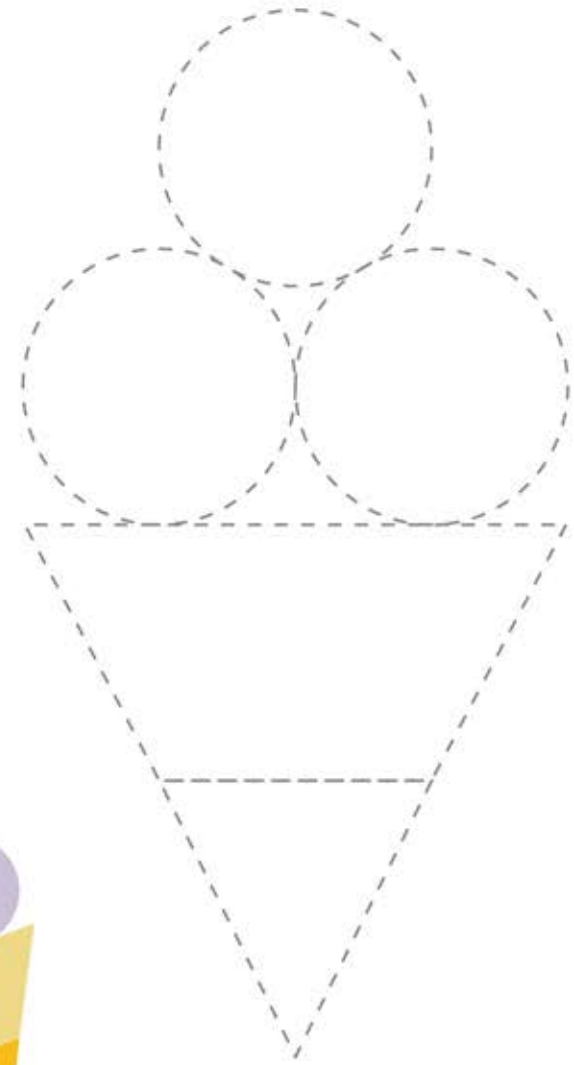

CANDY : 사탕

ICECREAM : 아이스크림

달콤한 사탕과 아이스크림을 생각해 보세요.
기분이 좋아지지 않나요?
즐겁게 사탕과 아이스크림을 완성해 보아요.

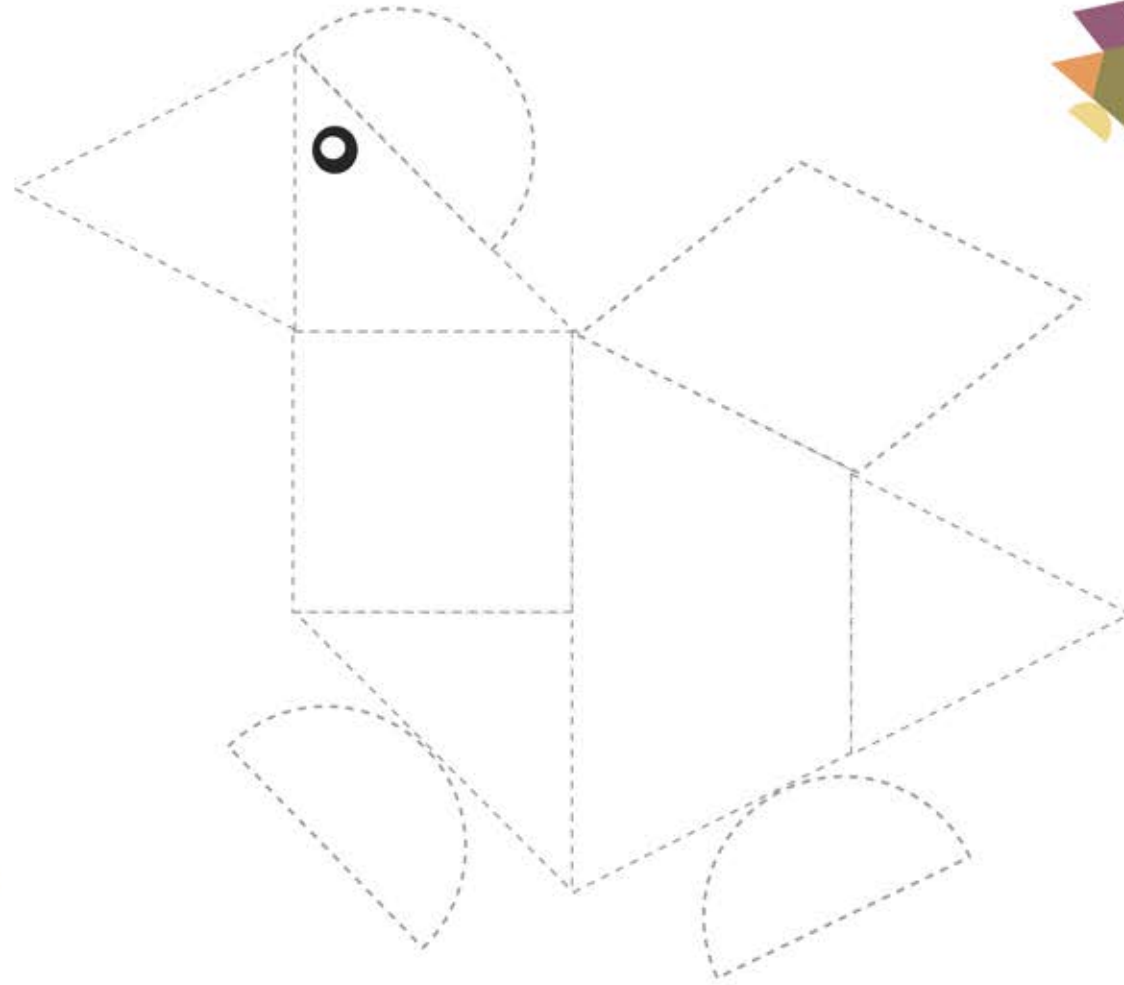

BRID : 새

맑은 하늘 위를 훨훨 날아다니는
새를 본 적이 있지요?
새의 모습을 상상하며 퍼즐을 맞춰보세요.

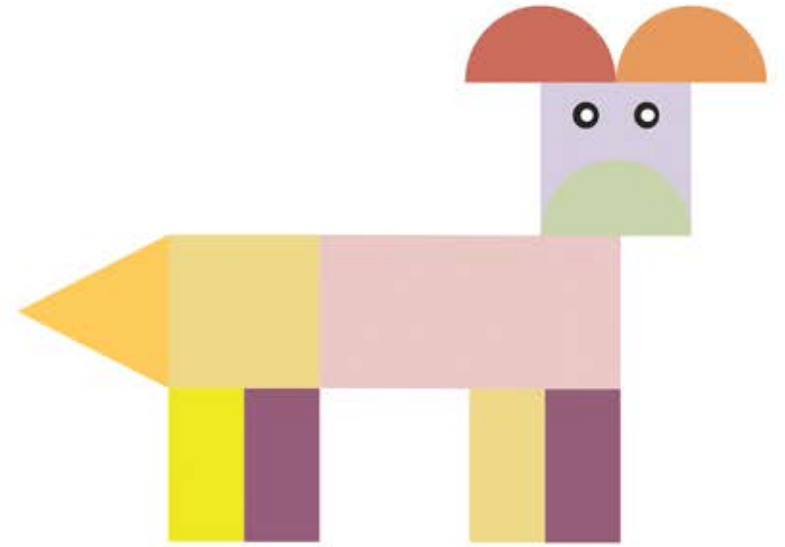
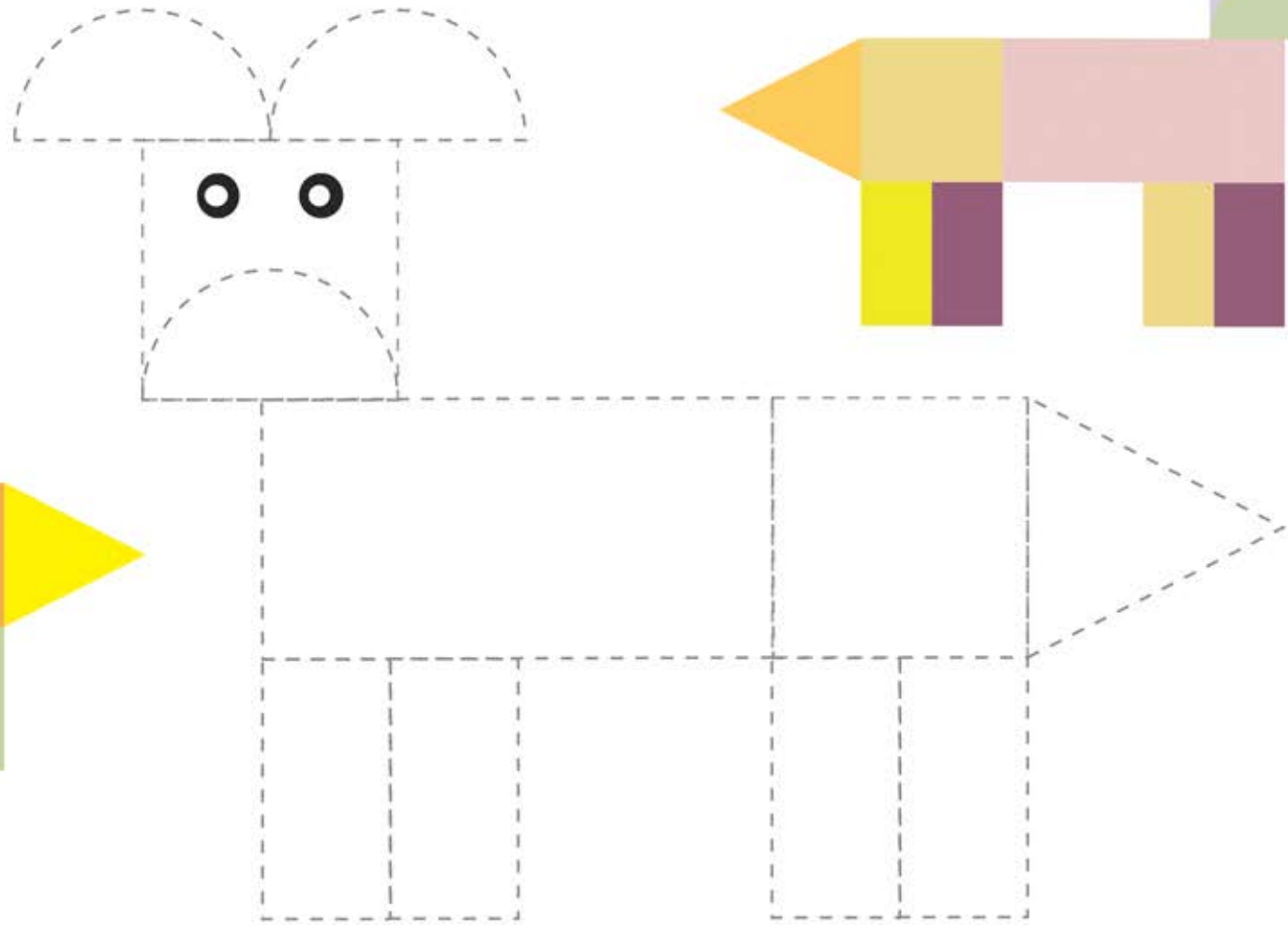
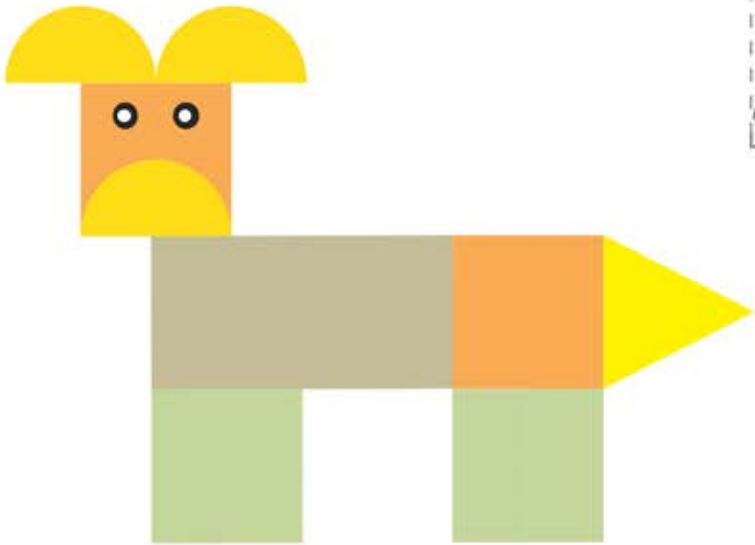

COW : 소

푸른 초원의 풀을 뜯어먹는
느릿느릿 소들.
소의 퍼즐을 맞춰 보세요.

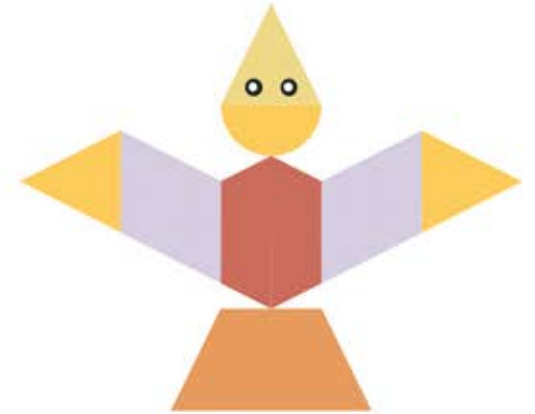
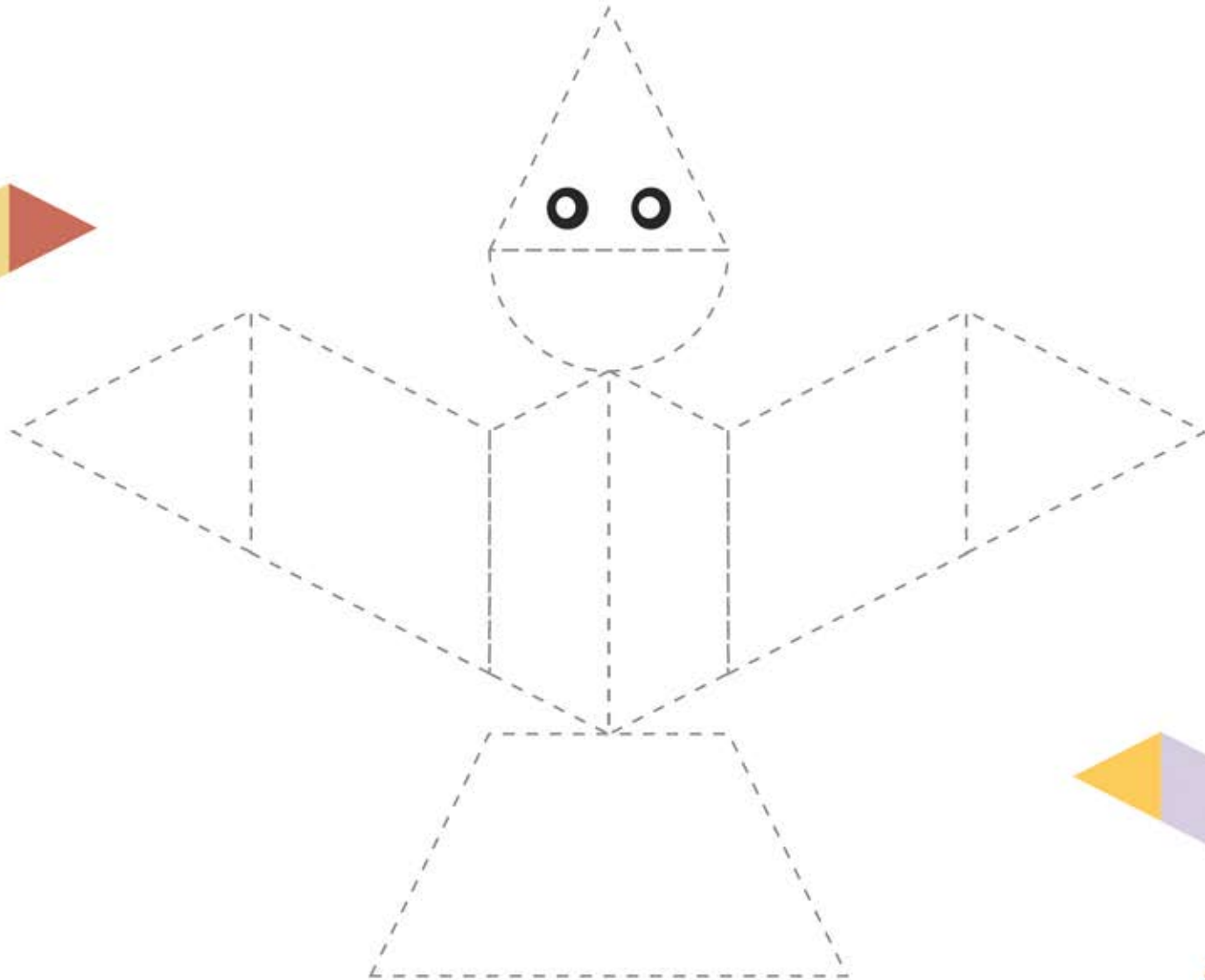
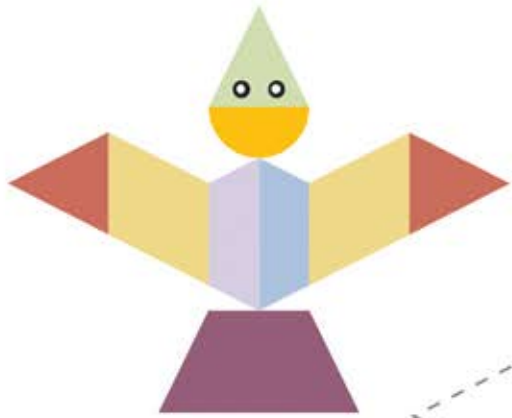

BIRD : 새

맑은 하늘 위를 훨훨 날아다니는
새를 본적이 있지요?
새의 모습을 상상하며 퍼즐을 맞춰 보세요.

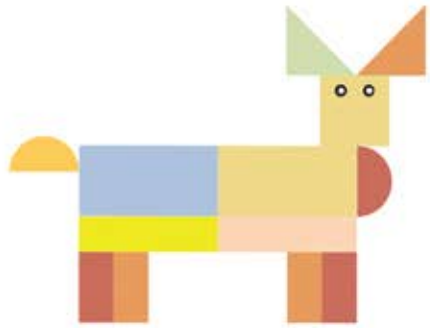
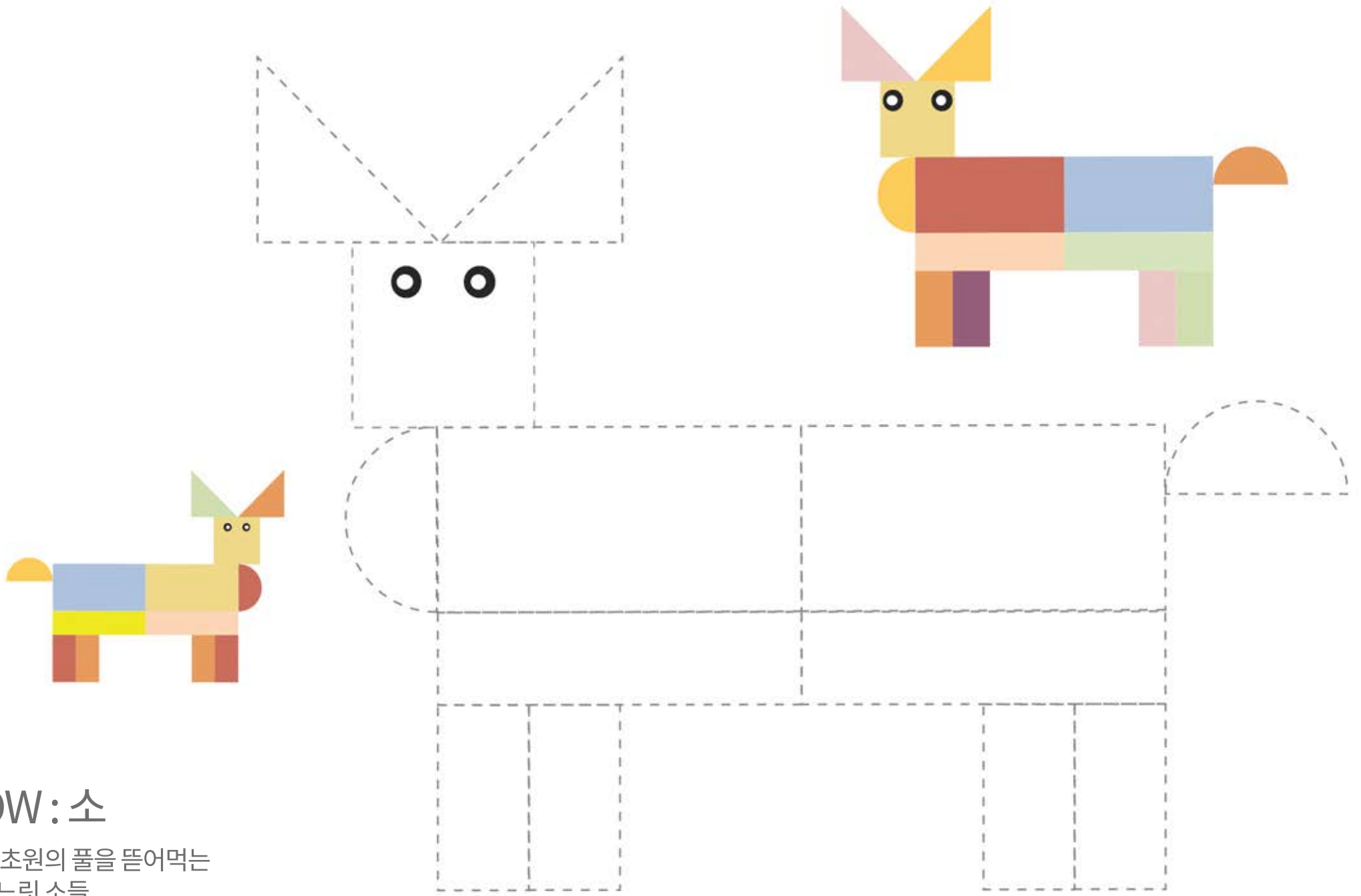

COW : 소

푸른 초원의 풀을 뜯어먹는
느릿느릿 소들.
소의 퍼즐을 맞춰 보세요.

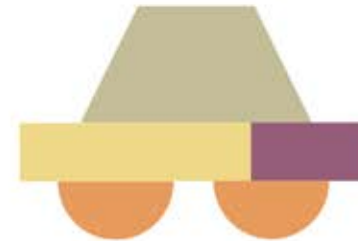
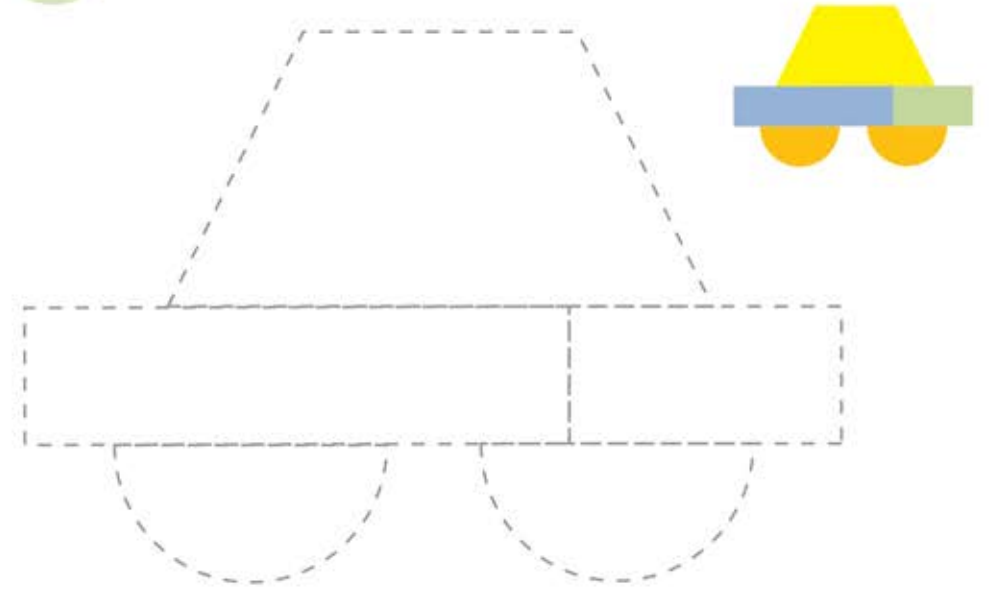
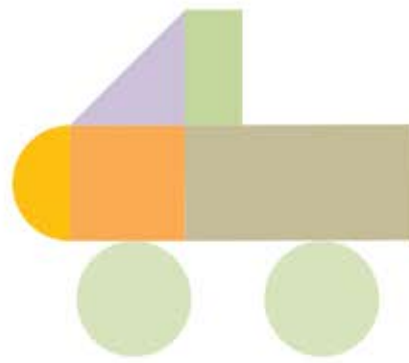
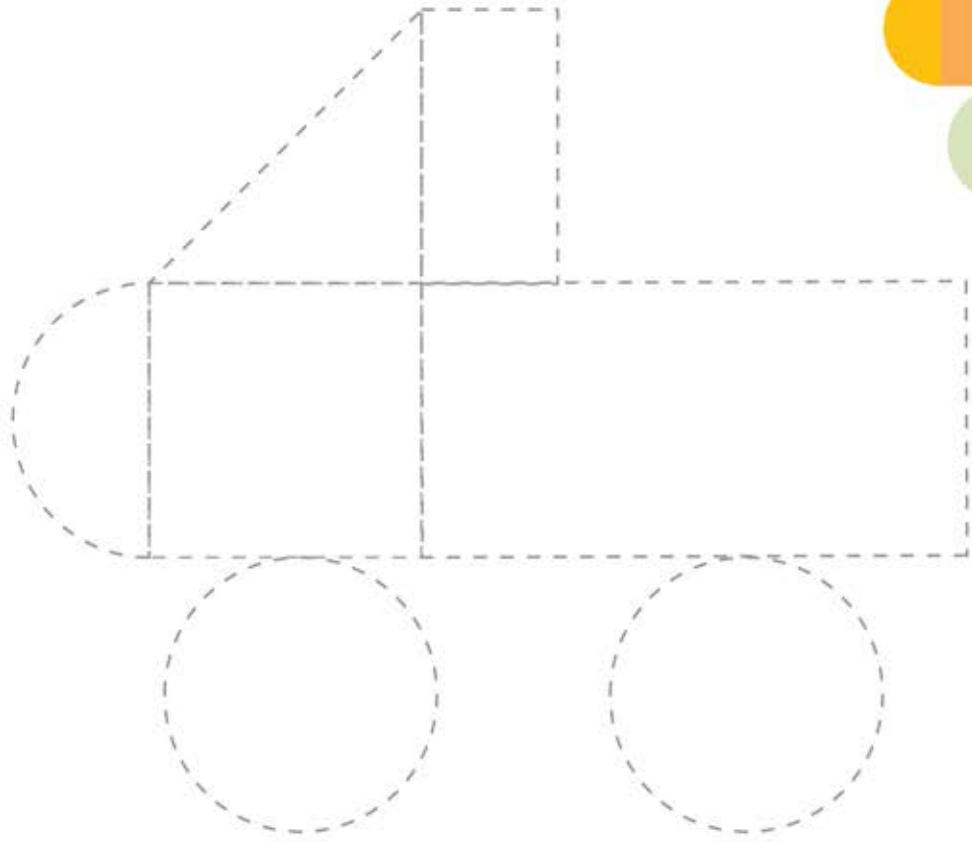

CAR: 자동차

부릉부릉! 엄마와 아빠가 운전하는
빠르고 멋진 자동차.
우리도 우리만의 자동차를 만들어 보아요.

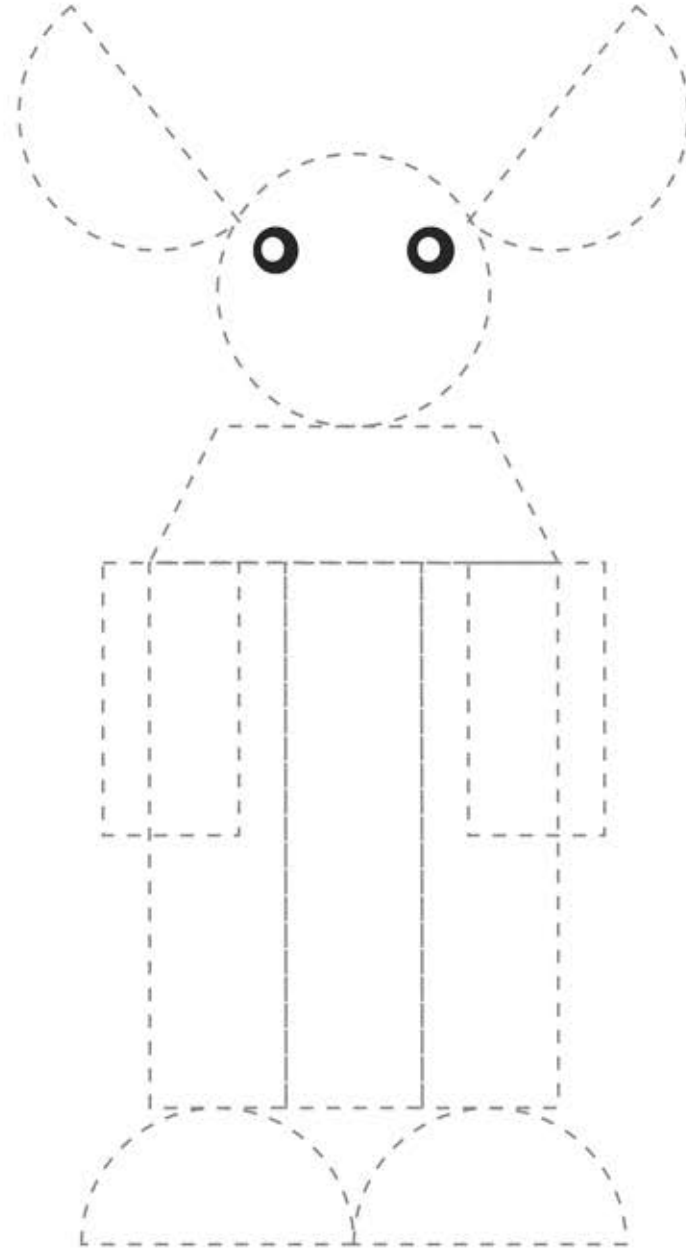
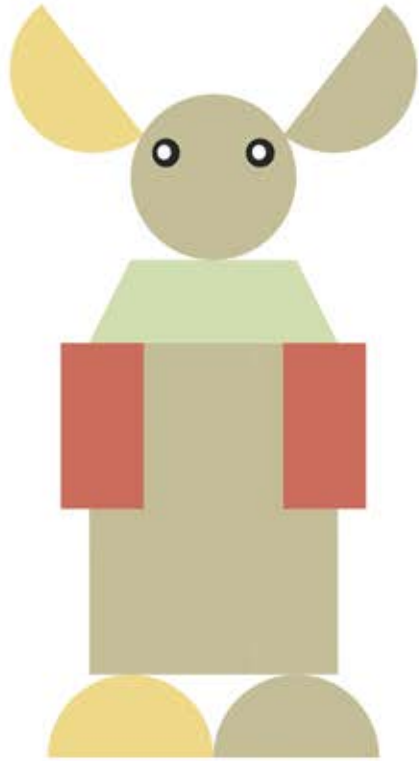

MOUSE : 쥐

찍찍, 작고 귀여운 쥐가
동그란 눈으로 무엇을 보고 있는 걸까요?
퍼즐을 맞추면서 상상해 보세요.

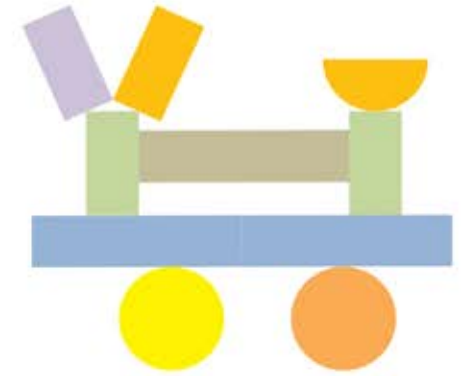
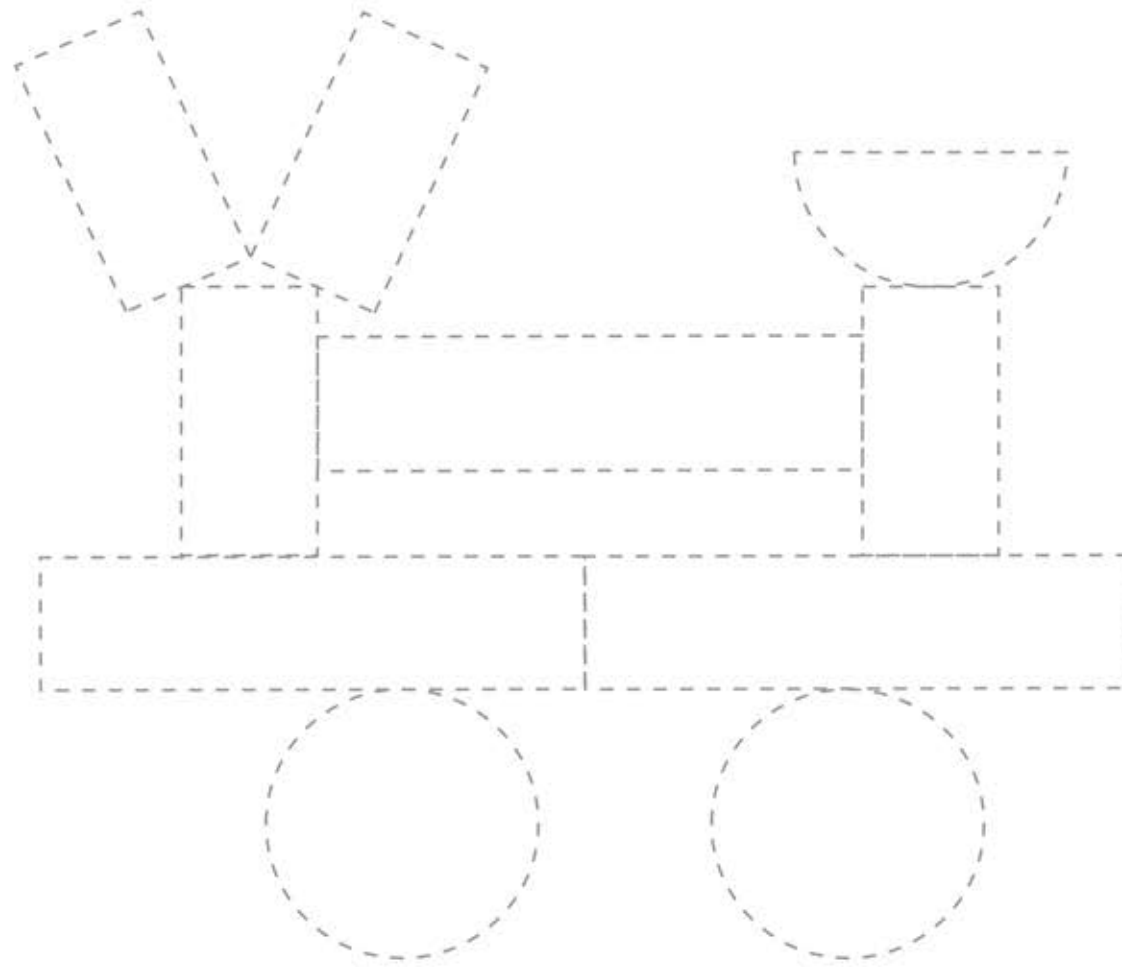

BICYCLE : 자전거

따르릉 따르릉 비켜나세요~
따스한 날씨에 자전거타고 나들이 가는 생각을 하며
자전거의 퍼즐조각을 맞춰요.

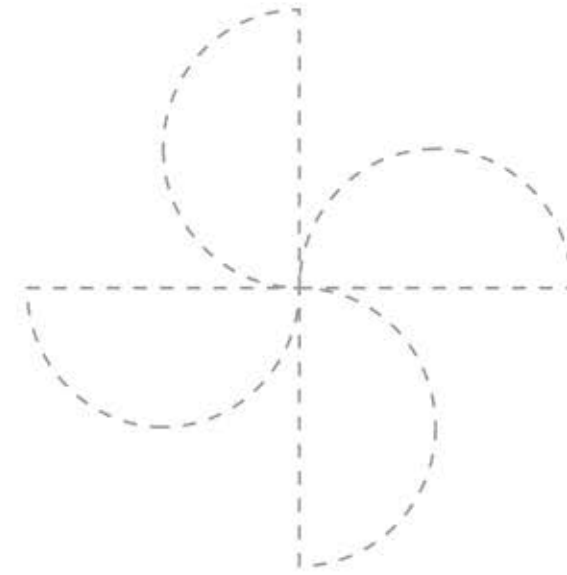
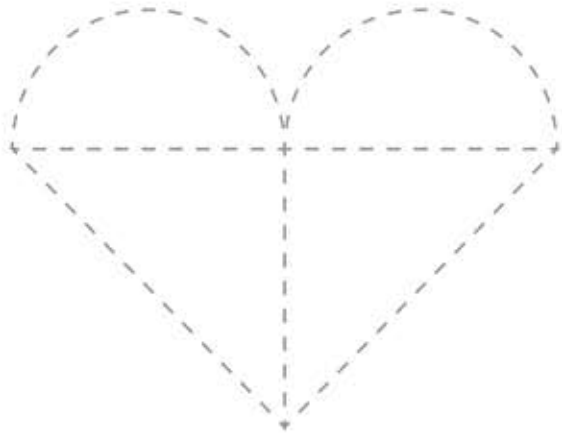

HEART : 하트

PINWHEEL : 바람개비

사랑의 마음을 가득 담아 하트를 만들어 보아요.
시원한 바람이 가득한 곳에서 날릴 바람개비를 만들어 보아요.

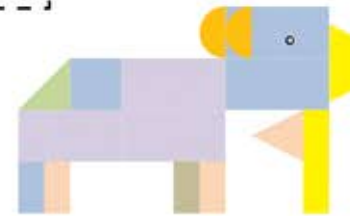
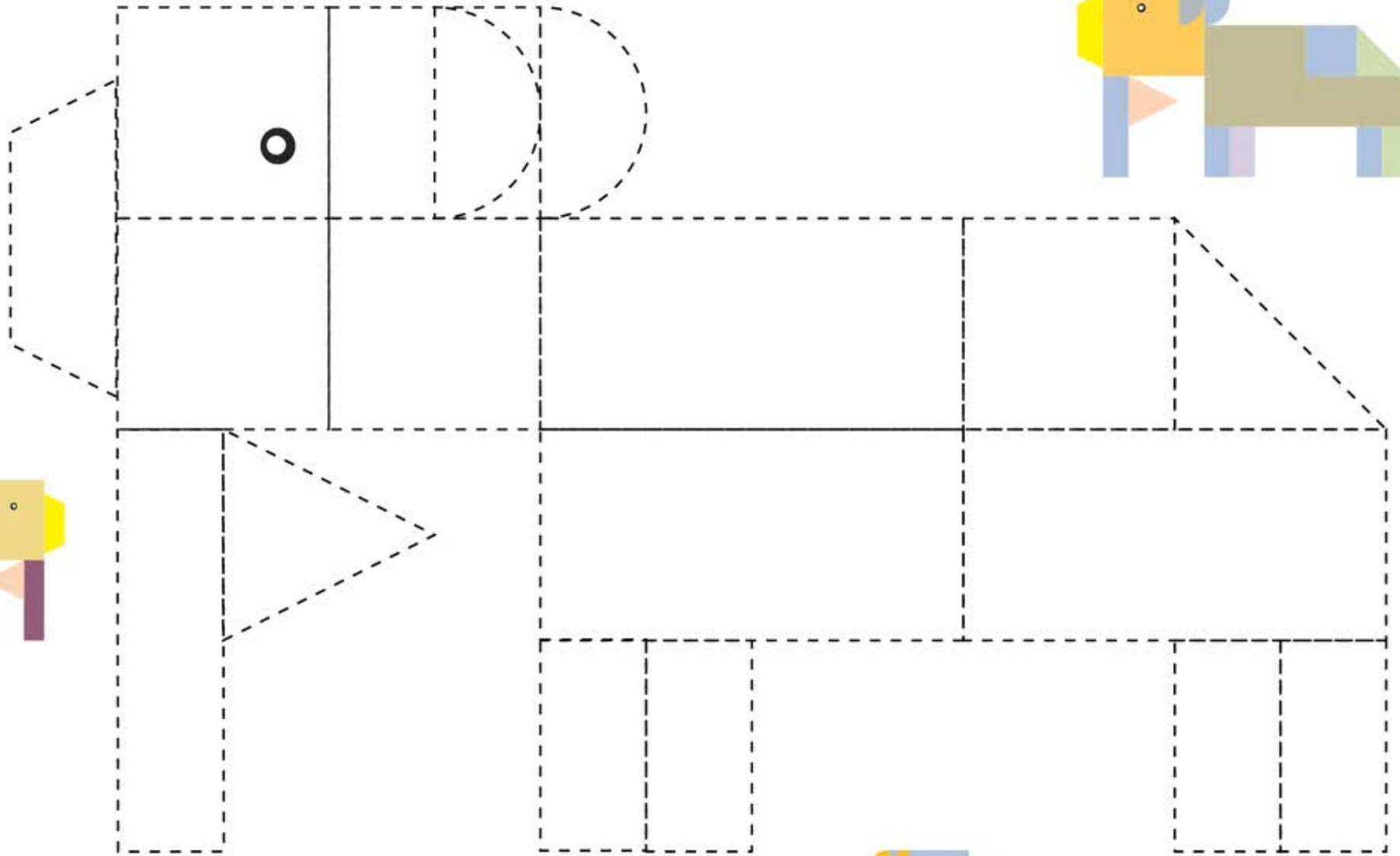
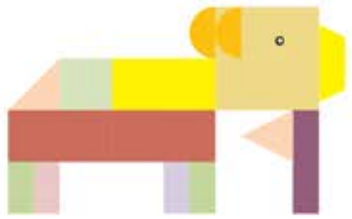
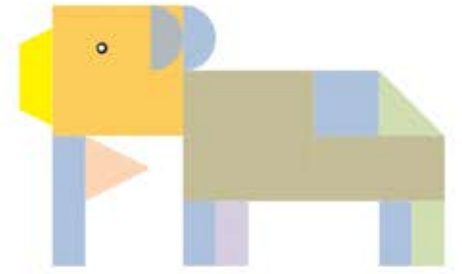

ELEPHANT : 코끼리

동물원에 가면 코가 길~고
몸집도 큰 코끼리를 볼 수 있어요.
코가 손인 코끼리를 만들어 보세요.

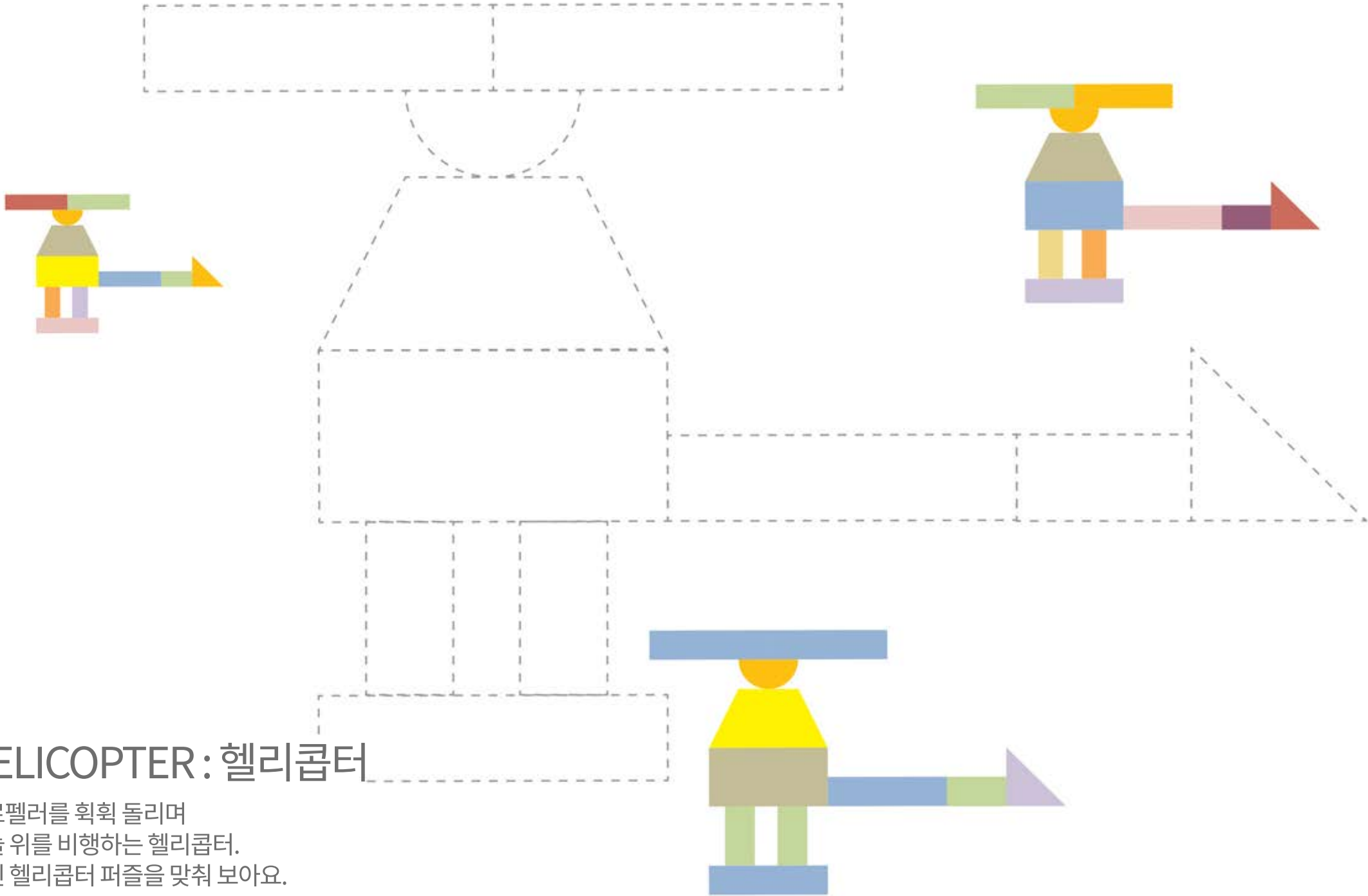

HELICOPTER : 헬리콥터

프로펠러를 휘휘 돌리며
하늘 위를 비행하는 헬리콥터.
멋진 헬리콥터 퍼즐을 맞춰 보아요.

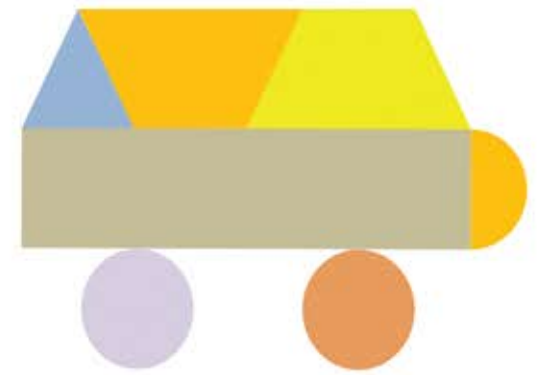
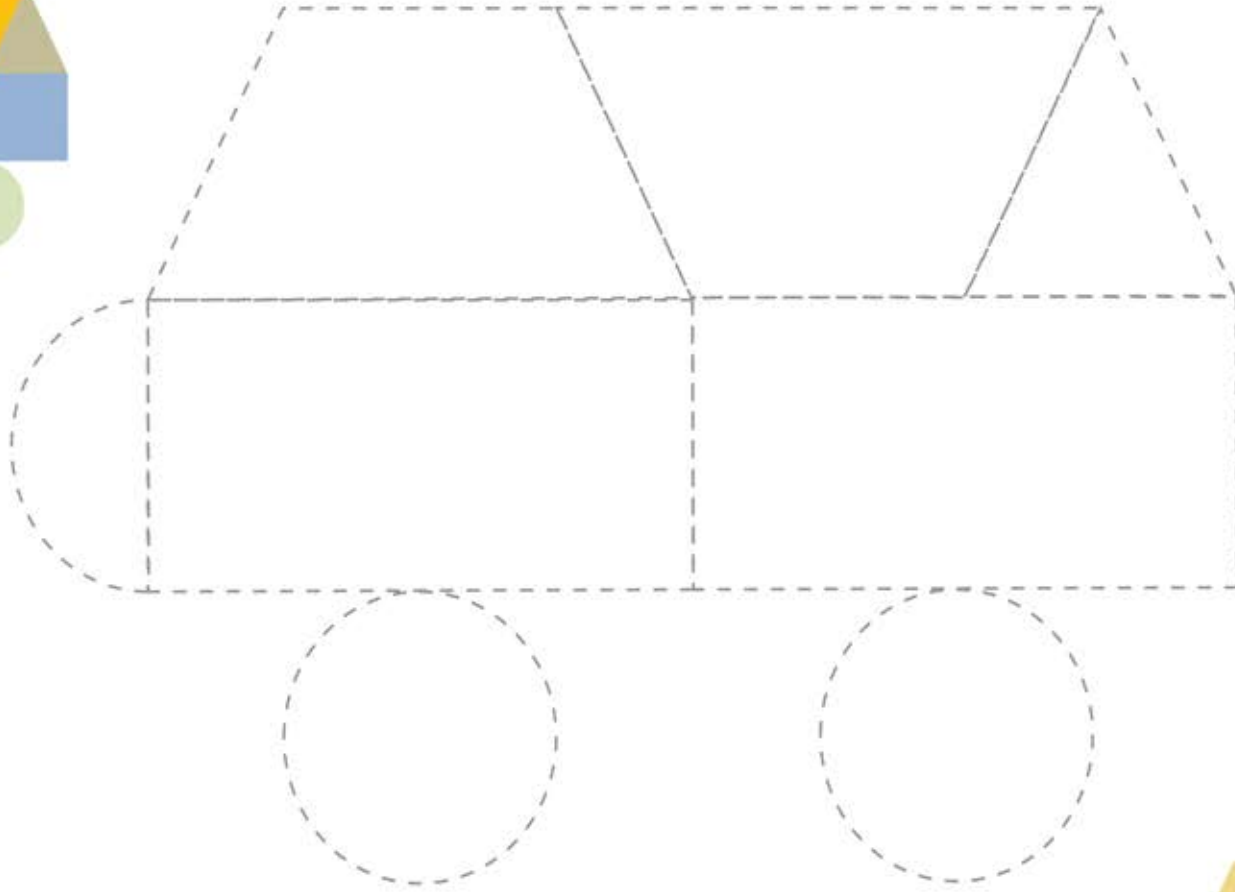

TRUCK : 화물차 / 트럭

무거운 짐을 나르는 큰 화물차를 본 적이 있지요?
커다란 화물칸 안에는 어떤 물건들이 들어 있을까요?
상상하며 화물차를 맞춰 보아요.



1. 위 매뉴얼을 프린트해서 사용하세요.
2. 실제크기와 다소 차이가 있습니다. 매뉴얼을 보면서 놀이하세요.
3. 아이가 매뉴얼 없이 놀이할 수 있도록 반복해서 함께 놀이해주세요.
4. 매뉴얼에 없는 무양을 상상해서 만들어 보세요.
5. 아이들에게는 시간이 필요합니다. 천천히 함께 놀이해주세요.

